

Lieferprogramm
VISS Fassade (10/2015)

Code A = Änderungen
Code E = Ergänzungen

Programme de livraison
VISS façade(10/2015)

Code A = Modifications
Code E = Compléments

Sales range
VISS façade (10/2015)

Code A = Modifications
Code E = Additions

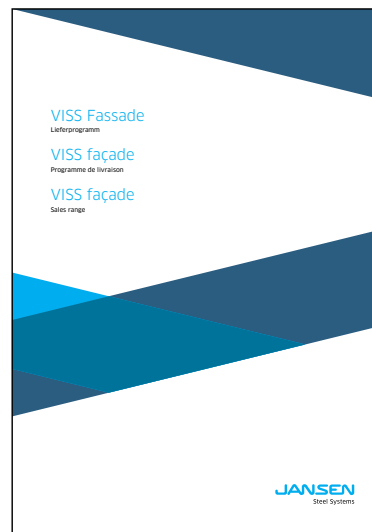

Seite Page Page	Code Code Code	Datum Date Date	Erläuterung Explication Explanation
22-9	A	01/2016	Hinweis hinzugefügt Remarque ajoutée Added note
22-8	E	02/2016	2 neue Profile: 76.143 Z und 76.144 Z 2 nouveaux profilés: 76.143 Z et 76.144 Z 2 new profiles: 76.143 Z and 76.144 Z

VISS Fassade

Lieferprogramm

VISS façade

Programme de livraison

VISS façade

Sales range

Systemübersicht

Merkmale
Zulassungen

Sommaire du système

Caractéristiques
Homologations

Summary of system

Characeteristics
Authorisations

2

Profilsortiment

Profile 50 und 60 mm
Deckprofile 50 und 60 mm
Zubehör

Assortiment de profilé

Profilés 50 et 60 mm
Profilés de recouvrement 50 et 60 mm
Accessoires

Range of profiles

Profiles 50 and 60 mm
Cover sections 50 and 60 mm
Accessories

6

Konstruktions-Hinweise

Schnittpunkte
Konstruktions-Details
Anschlüsse am Bau
System-Hinweise

Indications du construction

Coupes de détails
Détails de construction
Raccords au mur
Remarques concernant les systèmes

Construction instructions **35**

Section details
Construction details
Attachment to structure
System instructions

Alle Ausführungen dieser Dokumentation haben wir sorgfältig und nach bestem Wissen zusammengestellt. Wir können aber keine Verantwortung für die Benützung der vermittelten Vorschläge und Daten übernehmen. Wir behalten uns technische Änderungen ohne Vorankündigung vor.
Aktuelle Version auf www.jansen.com

Nous avons apporté le plus grand soin à l'élaboration de cette documentation. Cependant, nous déclinons toute responsabilité pour l'utilisation faite de nos propositions et de nos données.
Nous nous réservons le droit de procéder à des modifications techniques sans préavis.
Version actuelle sur www.jansen.com

All the information contained in this documentation is given to the best of our knowledge and ability. However, we decline all responsibility for the use made of these suggestions and data.
We reserve the right to effect technical modifications without prior warning.
Current version available at www.jansen.com

Merkmale

Caractéristiques

Characteristics

- CE-Kennzeichnung nach EN 13830
- U_{CW} , eingebaut Werte bis $0.73 \text{ W/m}^2\text{K}$
- U_f Werte bis $0.65 \text{ W/m}^2\text{K}$
- Ansichtsbreiten 50 und 60 mm
- Füllelementstärken 6 bis 70 mm
- Standardprofile ab Lager mit I_x Werten bis 1964 cm^4
- Füllelementgewichte bis 1800 kg
- Kombinierbar mit der Aufsatzkonstruktion VISS Basic, der Brandschutzlösung VISS Fire und der Einbruchhemmenden Variante VISS RC

- Marquage CE selon EN 13830
- Valeurs U_{CW} (monté) jusqu'à $0.73 \text{ W/m}^2\text{K}$
- Valeurs U_f jusqu'à $0.65 \text{ W/m}^2\text{K}$
- Largeurs de face 50 et 60 mm
- Éléments de remplissage de 6 à 70 mm d'épaisseur
- Profilés standard disponibles en magasin avec valeurs I_x jusqu'à 1964 cm^4
- Poids de remplissage jusqu'à 1800 kg
- Combinable avec la construction rapportée VISS Basic, la protection incendie VISS Fire et la variante anti-effraction VISS RC









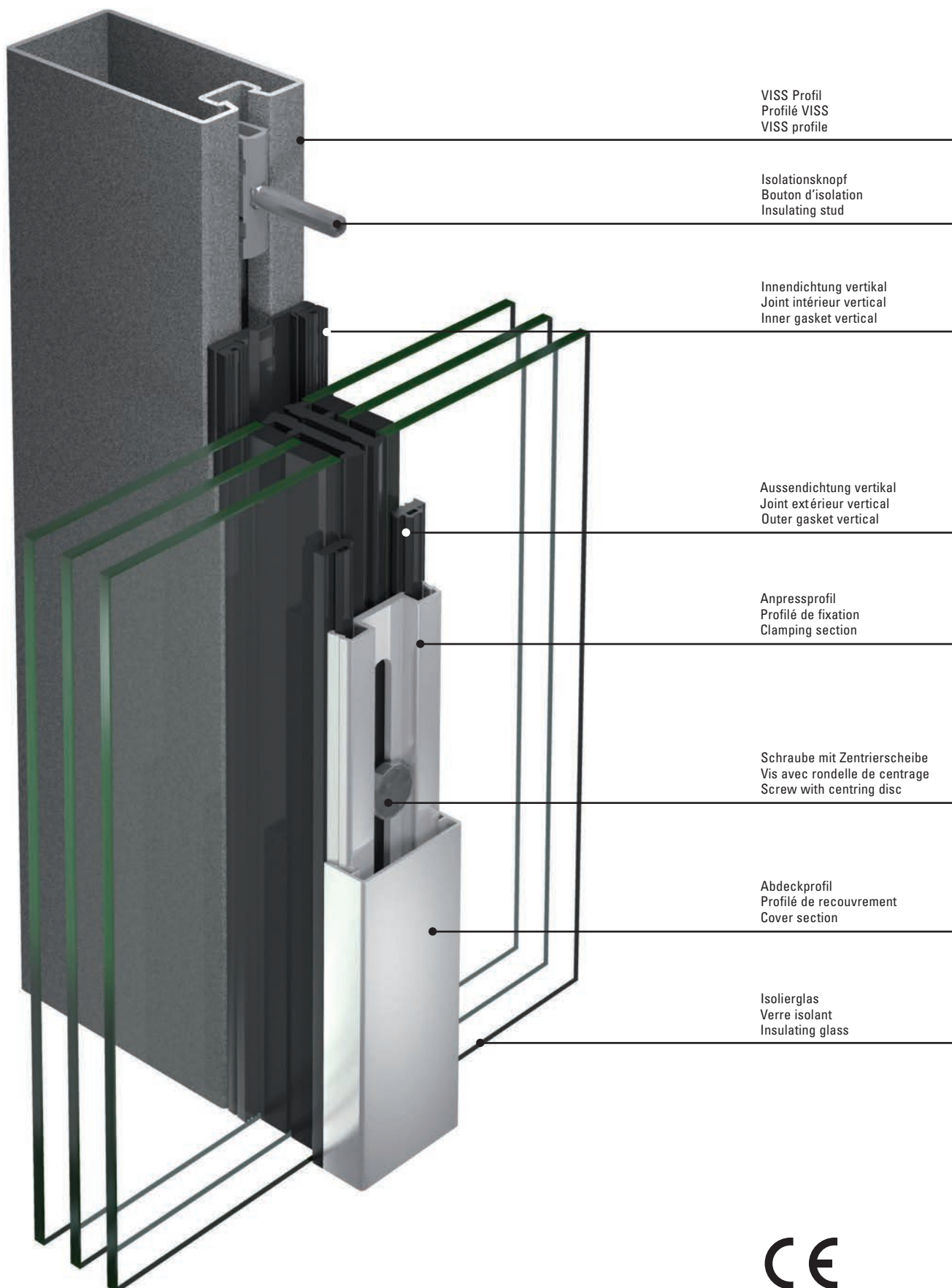

VISS Fassade

VISS façade

VISS façade

- CE marking in accordance with EN 13830
- U_{CW} , installed values to $0.73 \text{ W/m}^2\text{K}$
- U_f values to $0.65 \text{ W/m}^2\text{K}$
- 50 and 60 mm face widths
- Infill panel thicknesses of 6 to 70 mm
- Standard profiles from stock with I_x values to 1964 cm^4
- Infill unit weights up to 1800 kg
- Can be combined with the VISS Basic add-on construction, the VISS Fire fire protection solution and the VISS RC burglar-resistant version



	Prüfungen (Prüfnorm) Essais (Norme d'essai) Tests (Test standard)	Klassifizierungs-Norm Norme de classification Classification standard	Werte Valeurs Values
	Schlagregendichtheit (EN 12155) Etanchéité à la pluie battante (EN 12155) Watertightness (EN 12155)	EN 12154	RE 1200
	Widerstand bei Windlast (EN 12179) Résistance à la pression du vent (EN 12179) Resistance to wind load (EN 12179)	EN 13116	Bemessungslast 2 kN/m ² Charge de calcul 2 kN/m ² Designed load 2 kN/m ²
	Luftdurchlässigkeit (EN 12153) Perméabilité à l'air (EN 12153) Air permeability (EN 12153)	EN 12152	Klasse AE Classe AE Class AE
	Wärmedurchgangskoeffizient (EN 13947) Transmission thermique (EN 13947) Thermal transmittance (EN 13947)	EN ISO 10077-2	ab $U_f > 0.65 \text{ W/m}^2\text{K}$ dès $U_f > 0.65 \text{ W/m}^2\text{K}$ from $U_f > 0.65 \text{ W/m}^2\text{K}$
	Schallschutz (EN ISO 140-3) Isolation phonique (EN ISO 140-3) Sound insulation (EN ISO 140-3)	EN ISO 717-1	R_w 47 dB (-1; -5) (C, Ctr)
	Einbruchhemmung Anti-effraction Burglar resistance	prEN 1627	RC2 / RC3 / RC4
	Durchschusshemmung (EN 1523) Résistance aux balles (EN 1523) Bullet proofing (EN 1523)	EN 1522	FB4 NS
	Stoßfestigkeit Résistance au chocs Impact strength	EN 14019	Klasse E5 / I5 Classe E5 / I5 Class E5 / I5
	Brandverhalten Réaction au feu Reaction to fire	EN 13501-1	Klasse E Classe E Class E
	Längsschalldämmung Isolation acoustique longitudinale Insulation against flanking transmission	prEN ISO 10848-2 (4/2004)	vertikal 62 dB horizontal 59 dB
	Technische Regeln für die Verwendung von absturz sichernden Verglasungen Règlement technique pour la sécurité anti-chute des vitrages The technical regulations for protecting glazing against falling out	TRAV	Kategorie A Catégorie A Category A

Avis Technique (Frankreich)
Fassade VISS TV 1S
Zulassung Nr. 02/12-1501,
C.S.T.B. Marne la Vallée/FR

Avis Technique (France)
Façade VISS TV 1S
Autorisation no 02/12-1501,
C.S.T.B. Marne la Vallée/FR

Avis Technique (France)
Façade VISS TV 1S
Autorisation nr. 02/12-1501,
C.S.T.B. Marne la Vallée/FR

Klemmverbindung (Deutschland)
AbZ Z-14.4-459 (Isolationsknöpfe)

Jonction par serrage (Allemagne)
AbZ Z-14.4-459 (bouton d'isolation)

Clamp connection (Germany)
AbZ Z-14.4-459 (insulation studs)

CWCT-Test
Die Fassade wurde nach den
Anforderungen des CWCT geprüft.

Test CWCT
La façade a été contrôlée suivant les
exigences du CWCT.

CWCT test
The facades were certified in compliance
with the requirements of the CWCT.

Luftdurchlässigkeit/
Wasserdichtheit: PASS
Zulässige Windlast 2400 Pa
Sicherheitslast 3600 Pa

Perméabilité à l'air/
Étanchéité à l'eau: PASS
Charge du vent admissible 2400 Pa
Charge de sécurité 3600 Pa

Air permeability/
Watertightness: PASS
Permissible wind load 2400 Pa
Security load 3600 Pa

Passivhaus-Zertifikat

Zertifikat
Zertifizierte Passivhaus Komponente
für kühl gemäßigtes Klima, gültig bis 31.12.2015

Passivhaus Institut
Dr. Wolfgang Feist
64283 Darmstadt
GERMANY

Category: **Pfosten-Riegel-Fassade**
Hersteller: **Jansen AG**
6463 Oberriet SG, SWITZERLAND
Produkt: **VISS HI**

Passivhaus Effizienzklasse

Folgende Behaglichkeitskriterien wurden für die
Zuerkennung des Zertifikates geprüft:

Mit $U_g = 0,7 \text{ W/(m}^2\text{K)}$ und bei einem Modulmaß von
1,20 m * 2,50 m ergibt sich:

$U_{CW} = 0,80 \text{ W/(m}^2\text{K)} \leq 0,80 \text{ W/(m}^2\text{K)}$

Einschließlich Einbauwärmeverluste erfüllt die Fassade
folgende Bedingung, vorausgesetzt der Einbau erfolgt wie im
Datenblatt angegeben bzw. thermisch gleich- oder höherwertig.

$U_{CW, einbaut} \leq 0,85 \text{ W/(m}^2\text{K)}$

Folgende Kennwerte wurden ermittelt:

	U-Wert [W/(m ² K)]	Breite [mm]	Ψ_g [W/(m ² K)]	f _{Rel=0,2} [-]
Abstandhalter			Swisspacer V*	
Riegel (t)	0,92	50	0,037	0,81
Mullion (m)	0,81	50	0,037	
Glasträger-Wärmebrücke χ_{G1} [W/K]:				0,008

*Spacers of lower thermal quality, especially those made of alu-
minium, lead to significantly higher thermal losses and lower
temperature factors.

Weitere Informationen siehe Datenblatt

www.passiv.de 0157cw03

ZERTIFIZIERTE
KOMPONENTE
Passivhaus Institut

Certificat maison passive

Certificate
Certified Passive House component
for cool, temperate climate, valid until 31.12.2015

Passive House Institute
Dr. Wolfgang Feist
64283 Darmstadt
GERMANY

Category: **Curtain Wall**
Manufacturer: **Jansen AG**
6463 Oberriet SG, SWITZERLAND
Product name: **VISS HI**

Passive House Efficiency Class

The following comfort criteria were used in
awarding this certificate:

Given a U_g value of $0,7 \text{ W/(m}^2\text{K)}$ and an element size of
1,20 m by 2,50 m,

$U_{CW} = 0,80 \text{ W/(m}^2\text{K)} \leq 0,80 \text{ W/(m}^2\text{K)}$

Taking into account the installation based thermal bridges, and
provided that the installation is, with regard to the thermal bridges,
equal or better than shown in the data sheet, the facade meets
the following criterion.

$U_{CW, einbaut} \leq 0,85 \text{ W/(m}^2\text{K)}$

Thermal data of the construction

	U-value [W/(m ² K)]	Width [mm]	Ψ_g [W/(m ² K)]	f _{Rel=0,2} [-]
Spacer			Swisspacer V*	
Transom (t)	0,92	50	0,037	0,81
Mullion (m)	0,81	50	0,037	
Thermal glass carrier bridge χ_{G1} [W/K]:				0,008

*Spacers of lower thermal quality, especially those made of alu-
minium, lead to significantly higher thermal losses and lower
temperature factors.

Further information see data sheet

www.passivehouse.com 0157cw03

CERTIFIED
COMPONENT
Passive House Institute

Passive house certificate

Certificate
Certified Passive House component
for cool, temperate climate, valid until 31.12.2015

Passive House Institute
Dr. Wolfgang Feist
64283 Darmstadt
GERMANY

Category: **Curtain Wall**
Manufacturer: **Jansen AG**
6463 Oberriet SG, SWITZERLAND
Product name: **VISS HI**

Passive House Efficiency Class

The following comfort criteria were used in
awarding this certificate:

Given a U_g value of $0,7 \text{ W/(m}^2\text{K)}$ and an element size of
1,20 m by 2,50 m,

$U_{CW} = 0,80 \text{ W/(m}^2\text{K)} \leq 0,80 \text{ W/(m}^2\text{K)}$

Taking into account the installation based thermal bridges, and
provided that the installation is, with regard to the thermal bridges,
equal or better than shown in the data sheet, the facade meets
the following criterion.

$U_{CW, einbaut} \leq 0,85 \text{ W/(m}^2\text{K)}$

Thermal data of the construction

	U-value [W/(m ² K)]	Width [mm]	Ψ_g [W/(m ² K)]	f _{Rel=0,2} [-]
Spacer			Swisspacer V*	
Transom (t)	0,92	50	0,037	0,81
Mullion (m)	0,81	50	0,037	
Thermal glass carrier bridge χ_{G1} [W/K]:				0,008

*Spacers of lower thermal quality, especially those made of alu-
minium, lead to significantly higher thermal losses and lower
temperature factors.

Further information see data sheet

www.passivehouse.com 0157cw03

CERTIFIED
COMPONENT
Passive House Institute

Profile 50 mm (Massstab 1:3)

Profils 50 mm (échelle 1:3)

Profiles 50 mm (scale 1:3)

VISS Fassade

VISS façade

VISS façade

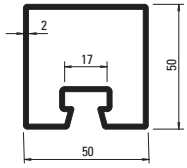

76.694
76.694 Z

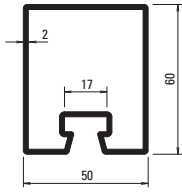

76.671
76.671 Z

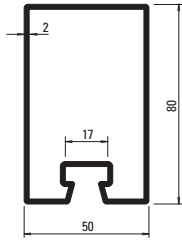

76.696
76.696 Z

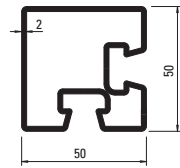

76.094
76.094 GV+GC

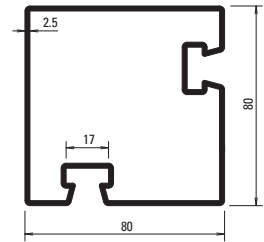

76.096
76.096 GV+GC

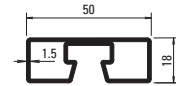

76.692
76.692 GV+GC

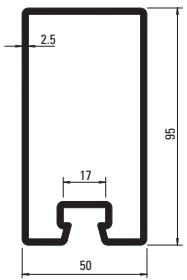

76.697
76.697 Z

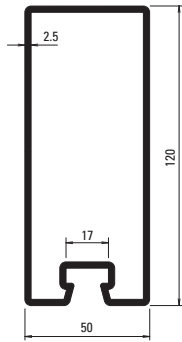

76.679
76.679 Z

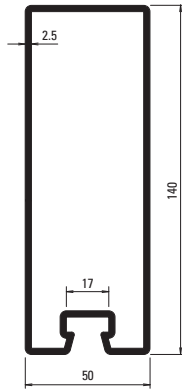

76.666
76.666 Z

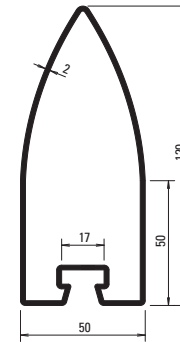

76.105
76.105 GV+GC

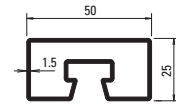

76.682
76.682 GV+GC

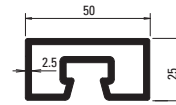

76.680
76.680 GV+GC

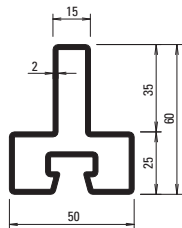

76.114
76.114 GV+GC

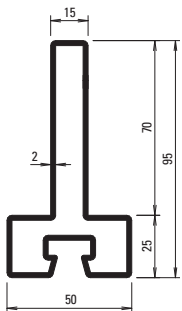

76.115
76.115 GV+GC

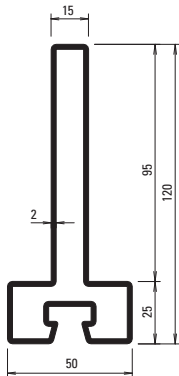

76.116
76.116 GV+GC

Profil-Nr.	G kg/m	F cm ²	I _x cm ⁴	W _x cm ³	I _y cm ⁴	W _y cm ³	U m ² /m	L mm
76.094	4,090	5,21	15,20	5,90	15,20	5,90	0,280	6000
76.096	6,000	7,64	68,50	16,79	68,53	16,79	0,391	6000
76.105	5,190	6,62	97,55	13,62	22,71	9,08	0,338	6000
76.666	7,910	10,1	240,0	32,10	43,50	17,40	0,412	6500
76.671	3,860	4,90	23,2	7,20	17,30	6,90	0,260	6500
76.679	7,120	9,07	162,0	25,20	37,90	15,20	0,373	6500
76.680	3,390	4,32	3,17	2,38	11,08	4,43	0,182	6100
76.682	2,120	2,70	2,34	1,81	7,20	2,90	0,190	6000
76.692	1,900	2,52	0,85	0,81	6,00	2,40	0,176	6000
76.694	3,500	4,50	15,0	5,70	14,80	5,90	0,240	6500
76.696	4,450	5,70	48,4	11,50	21,80	8,70	0,300	6500
76.697	6,100	7,90	92,0	17,90	31,00	12,40	0,330	6500
76.114	3,820	4,87	15,36	4,14	9,79	3,91	0,251	6000
76.115	4,920	6,27	54,76	9,31	10,38	4,15	0,321	6000
76.116	5,710	7,27	105,00	14,31	10,81	4,32	0,371	6000

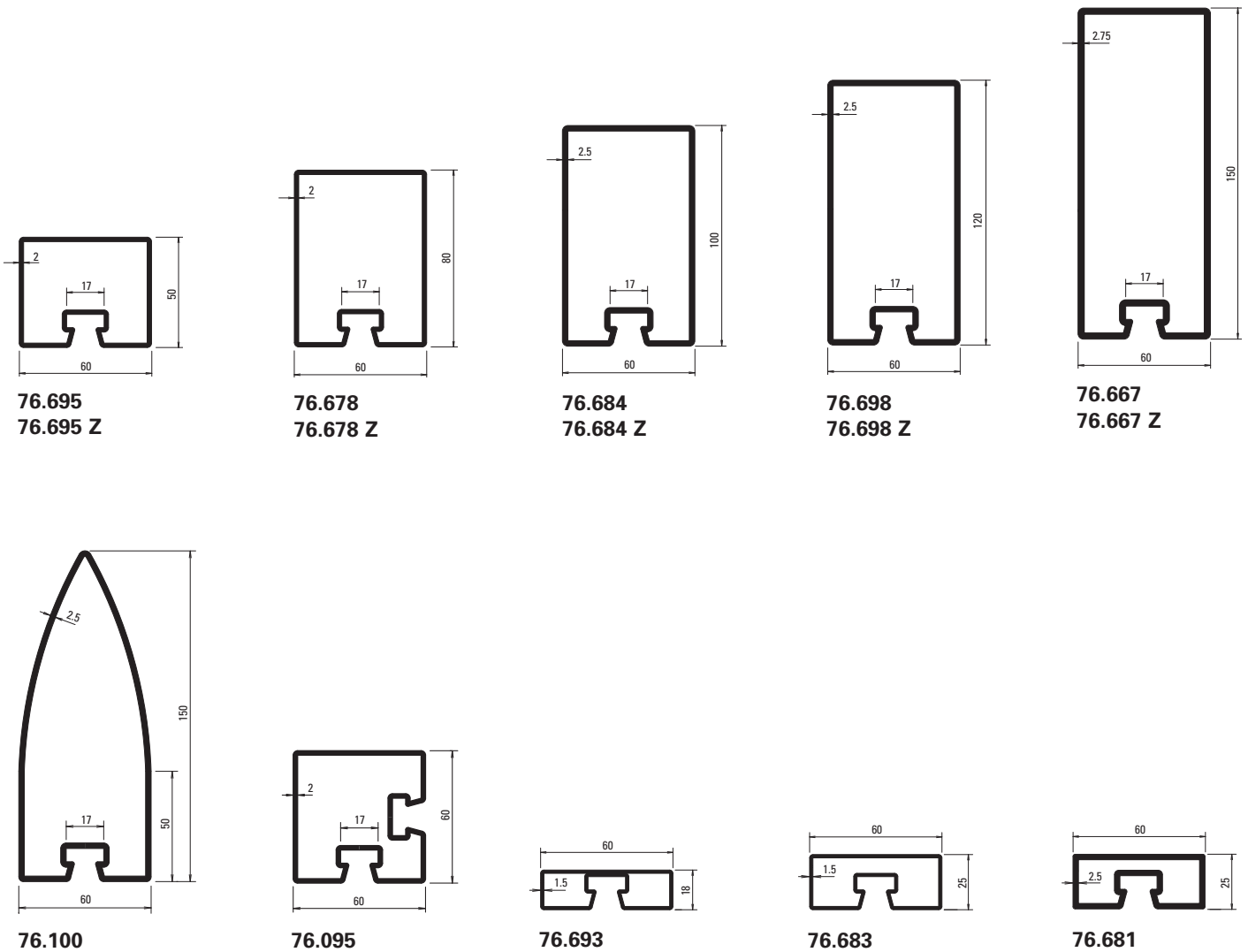

76.100

76.095

76.693

76.683

76.681

Artikelbibliothek
 Bibliothèque des articles
 Article library

DXF **DWG**

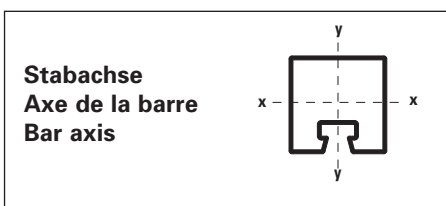

Profil-Nr.	G kg/m	F cm ²	I _x cm ⁴	W _x cm ³	I _y cm ⁴	W _y cm ³	U m ² /m	L mm
76.095	4,750	6,05	27,2	8,56	27,17	8,56	0,311	6000
76.100	7,840	9,98	231,8	26,07	47,87	15,96	0,409	6000
76.667	9,530	12,10	343,0	43,00	75,10	25,00	0,452	6500
76.678	4,800	6,11	53,9	12,60	33,20	11,10	0,320	6500
76.681	3,790	4,82	3,81	2,89	17,29	5,76	0,202	6100
76.683	2,360	3,00	2,77	2,14	11,20	3,70	0,210	6000
76.684	6,730	8,57	114,0	21,30	48,30	16,10	0,352	6500
76.693	2,140	2,82	1,20	1,10	9,50	3,10	0,196	6000
76.695	3,800	4,90	17,6	6,70	22,80	7,60	0,260	6500
76.698	7,500	9,67	183,0	28,30	55,50	18,50	0,400	6500

Profile 60 mm (Massstab 1:3)

Profils 60 mm (échelle 1:3)

Profiles 60 mm (scale 1:3)

VISS Fassade

VISS façade

VISS façade

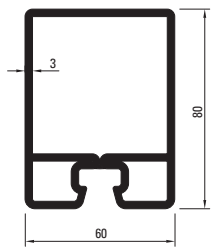

76.143 Z

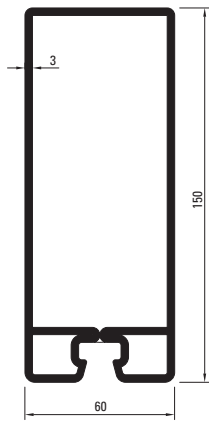

76.144 Z

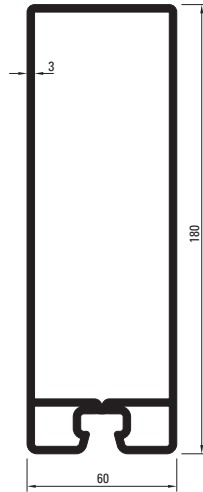

76.140 Z

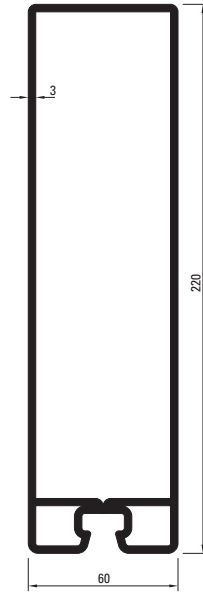

76.141 Z

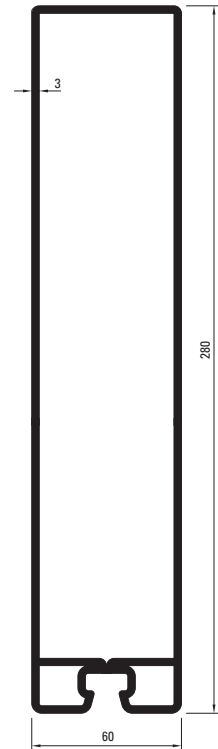

76.142 Z

Profil-Nr.	G kg/m	F cm ²	I _x cm ⁴	W _x cm ³	I _y cm ⁴	W _y cm ³	U m ² /m	L mm
76.140 Z	13,040	16,61	621,8	61,77	95,44	31,81	0,516	8000
76.141 Z	14,920	19,01	1046,2	85,16	114,95	38,36	0,596	8000
76.142 Z	17,750	22,61	1964,8	126,37	144,22	48,07	0,716	10000
76.143 Z	8,340	10,62	71,71	17,17	45,32	15,11	0,316	6500
76.144 Z	11,630	14,82	347,15	44,36	79,16	26,39	0,456	6500

Deckprofile 50 mm (Masstab 1:3)
Profils de recouvrement 50 mm (échelle 1:3)
Cover sections 50 mm (scale 1:3)

VISS Fassade
 VISS façade
 VISS façade

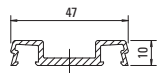

407.800

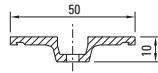

407.821



407.823

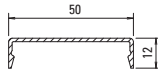

407.860

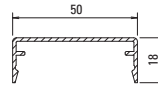

407.861

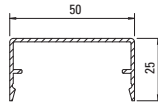

407.862

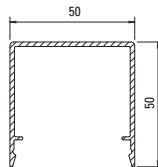

407.863

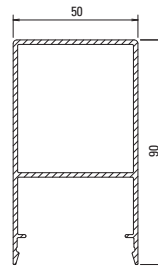

407.864

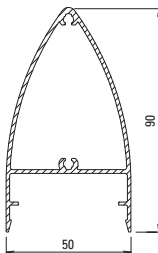

407.914

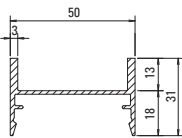

407.900

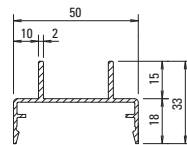

407.911

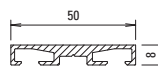

407.818**

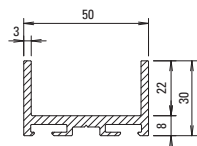

407.817*

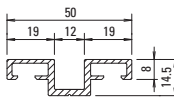

407.858**

* Sonderkonstruktion (nach
 Produktnorm EN 13830
 nicht geprüft). Einsatz nur im
 Pfostenbereich.

* Construction spéciale (non
 contrôlé selon la norme
 produit EN 13830). Utilisation
 uniquement dans la zone
 du montant.

* Special construction (Not
 tested in accordance with the
 EN 13830 product standard).
 Only for use in mullion area.

** Sonderkonstruktion (nach
 Produktnorm EN 13830
 nicht geprüft).

** Construction spéciale (non
 contrôlé selon la norme
 produit EN 13830).

** Special construction (Not
 tested in accordance with the
 EN 13830 product standard).

Profil-Nr.	G kg/m	U m ² /m	P m ² /m	L mm
407.800	0,414	0,160		6000
407.821	0,440	0,143	0,067	6000
407.823	0,076	0,043	0,019	6000
407.817	1,030	0,253	0,154	6000
407.818	0,520	0,176	0,066	6000
407.858	0,530	0,203	0,087	6000
407.860	0,266	0,147	0,072	6000

Profil-Nr.	G kg/m	U m ² /m	P m ² /m	L mm
407.861	0,341	0,185	0,084	6000
407.862	0,394	0,213	0,098	6000
407.863	0,660	0,313	0,148	6000
407.864	1,344	0,360	0,228	6000
407.900	0,556	0,240	0,138	6000
407.911	0,510	0,245	0,146	6000
407.914	0,980	0,301	0,193	6000

Deckprofile 50 mm (Masstab 1:3)
Profils de recouvrement 50 mm (échelle 1:3)
Cover sections 50 mm (scale 1:3)

VISS Fassade
 VISS façade
 VISS façade

Edelstahl-Abdeckprofile
Werkstoff 1.4301 (AISI 304)
 geschliffen, Korn 220/240,
 mit Schutzfolie

Profilé de recouvrement acier Inox
Qualité 1.4301 (AISI 304)
 meulé, degré 220/240,
 avec feuille de protection

Stainless steel cover sections
Material 1.4301 (AISI 304)
 polished, grain 220/240,
 with protective film

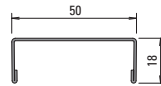
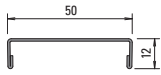

400.860

400.861

Edelstahl-Abdeckprofile
Werkstoff 1.4401 (AISI 316)
 geschliffen, Korn 220/240,
 mit Schutzfolie

Profilé de recouvrement acier Inox
Qualité 1.4401 (AISI 316)
 meulé, degré 220/240,
 avec feuille de protection

Stainless steel cover sections
Material 1.4401 (AISI 316)
 polished, grain 220/240,
 with protective film

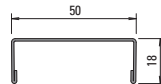
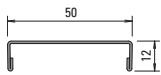

400.862

400.863

Profil-Nr.	G kg/m	L mm
400.860	0,644	6000
400.861	0,734	6000

Profil-Nr.	G kg/m	L mm
400.862	0,652	6000
400.863	0,744	6000

Artikelbibliothek
 Bibliothèque des articles
 Article library

DXF

DWG

Deckprofile 60 mm (Masstab 1:3)
Profils de recouvrement 60 mm (échelle 1:3)
Cover sections 60 mm (scale 1:3)

VISS Fassade
 VISS façade
 VISS façade

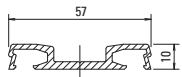

407.802

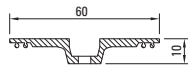

407.822



407.823

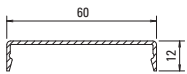

407.865

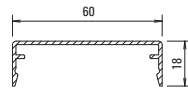

407.866

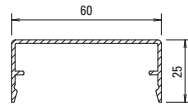

407.867

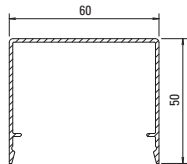

407.868

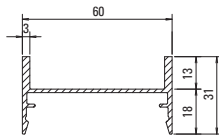

407.901

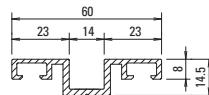

407.859*

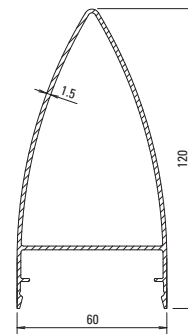

407.915

Profil-Nr.	G kg/m	U m ² /m	P m ² /m	L mm
407.802	0,558	0,190		6000
407.822	0,530	0,163	0,051	6000
407.823	0,076	0,043	0,019	6000
407.865	0,304	0,167	0,082	6000
407.866	0,379	0,205	0,094	6000
407.867	0,432	0,223	0,108	6000

Profil-Nr.	G kg/m	U m ² /m	P m ² /m	L mm
407.868	0,750	0,330	0,160	6000
407.859	0,643	0,233	0,097	6000
407.901	0,590	0,255	0,148	6000
407.915	1,258	0,373	0,240	6000

* Sonderkonstruktion (nach Produktnorm EN 13830 nicht geprüft). Einsatz nur im Pfostenbereich.

* Construction spéciale (non contrôlé selon la norme produit EN 13830). Utilisation uniquement dans la zone du montant.

* Special construction (Not tested in accordance with the EN 13830 product standard). Only for use in mullion area.



455.537

Innendichtung vertikal
50 mm breit, EPDM schwarz

VE = 50 m

455.537

Joint intérieur vertical
largeur 50 mm, EPDM noir

UV = 50 m

455.537

Inner gasket, vertical
50 mm wide, EPDM black

PU = 50 m



455.558

Innendichtung horizontal
50 mm breit, EPDM schwarz

VE = 50 m

455.558

Joint intérieur horizontal
largeur 50 mm, EPDM noir

UV = 50 m

455.558

Inner gasket, horizontal
50 mm wide, EPDM black

PU = 50 m



455.538

Innendichtung vertikal
60 mm breit, EPDM schwarz

VE = 50 m

455.538

Joint intérieur vertical
largeur 60 mm, EPDM noir

UV = 50 m

455.538

Inner gasket, vertical
60 mm wide, EPDM black

PU = 50 m

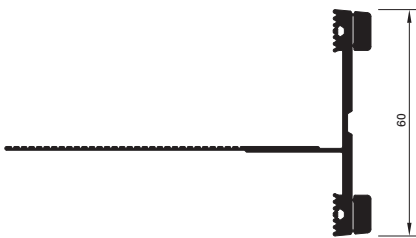

455.559

Innendichtung horizontal
60 mm breit, EPDM schwarz

VE = 50 m

455.559

Joint intérieur horizontal
largeur 60 mm, EPDM noir

UV = 50 m

455.559

Inner gasket, horizontal
60 mm wide, EPDM black

PU = 50 m

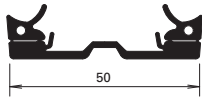

455.545

Innendichtung vertikal
50 mm breit, für Segment-
verglasungen, EPDM schwarz

VE = 50 m

455.545

Joint intérieur vertical
largeur 50 mm, pour vitrage
segmenté, EPDM noir

UV = 50 m

455.545

Inner gasket, vertical
50 mm wide, for segmental
glazing, EPDM black

PU = 50 m



455.546

Innendichtung vertikal
60 mm breit, für Segment-
verglasungen, EPDM schwarz

VE = 50 m

455.546

Joint intérieur vertical
largeur 60 mm, pour vitrage
segmenté, EPDM noir

UV = 50 m

455.546

Inner gasket, vertical
60 mm wide, for segmental
glazing, EPDM black

PU = 50 m



455.501

Aussendichtung
für Anpressprofile,
EPDM schwarz

VE = 100 m

Einsatz:
Pfosten, Riegel oben

455.501

Joint extérieur
pour profilés de fixation,
EPDM noir

UV = 100 m

Utilisation:
Montant, traverse supérieur

455.501

Outer gasket
for clamping sections,
EPDM black

PU = 100 m

Application:
Mullion, transoms top



455.502

Aussendichtung
für Anpressprofile,
EPDM schwarz

VE = 50 m

Einsatz:
Riegel unten

455.502

Joint extérieur
pour profilés de fixation,
EPDM noir

UV = 50 m

Utilisation:
Traverse inférieur

455.502

Outer gasket
for clamping sections,
EPDM black

PU = 50 m

Application:
Transom bottom



452.499

Entspannungsstück
Kunststoff schwarz

VE = 100 Stück

Einsatz:
Riegel unten, als Entspannungs-
und Entwässerungsöffnung
(Dichtung 455.502)

452.499

Pièce de décompression
matière plastique noire

UV = 100 pièces

Utilisation:
Traverse inférieur,
pour l'aération et l'écoulement
(joint 455.502)

452.499

Stress relieving block
plastic, black

PU = 100 pieces

Application:
Transom bottom,
for stress relieving and drainage
opening (gasket 455.502)



455.505

Aussendichtung
für Anpressprofile,
EPDM schwarz

VE = 100 m

Einsatz:
Pfosten bei
Segmentverglasungen bis 15°

455.505

Joint extérieur
pour profilés de fixation,
EPDM noir

UV = 100 m

Utilisation:
Montant à vitrage segmenté
jusqu'à 15°

455.505

Outer gasket
for clamping sections,
EPDM black

PU = 100 m

Application:
mullions with segmental
glazing up to 15°



455.565

Ausgleichsdichtung 2 mm
EPDM schwarz,
für Innendichtungen 455.537/
455.538/455.558/455.559

VE = 50 m

455.565

Joint de compensation 2 mm
EPDM noir, pour joint
intérieur 455.537/
455.538/455.558/455.559

UV = 50 m

455.565

Compensating gasket 2 mm
EPDM black,
for inner gasket 455.537/
455.538/455.558/455.559

PU = 50 m



455.566

Ausgleichsdichtung 4 mm
EPDM schwarz,
für Innendichtungen 455.537/
455.538/455.558/455.559

VE = 50 m

455.566

Joint de compensation 4 mm
EPDM noir, pour joint
intérieur 455.537/
455.538/455.558/455.559

UV = 50 m

455.566

Compensating gasket 4 mm
EPDM black,
for inner gasket 455.537/
455.538/455.558/455.559

PU = 50 m



455.567

Ausgleichsdichtung 6 mm
EPDM schwarz,
für Innendichtungen 455.537/
455.538/455.558/455.559

VE = 50 m

455.567

Joint de compensation 6 mm
EPDM noir, pour joint
intérieur 455.537/
455.538/455.558/455.559

UV = 50 m

455.567

Compensating gasket 6 mm
EPDM black,
for inner gasket 455.537/
455.538/455.558/455.559

PU = 50 m

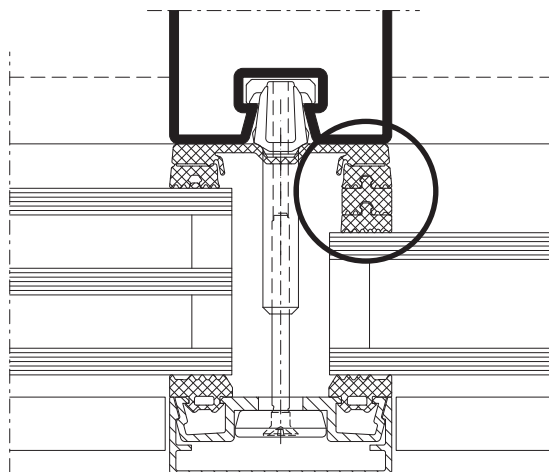

Es können maximal 2 Ausgleichsdichtungen aufgesteckt werden, wobei eine Erhöhung von 10 mm nicht überschritten werden sollte.

Il est possible d'ajouter au maximum 2 joints de compensation, sans dépasser un rehaussement de 10 mm.

A maximum of 2 compensating gaskets can be inserted, provided that the overall depth of the gasket does not exceed 10 mm.

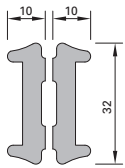

450.065
Dämmprofil Pfosten
aus Polyethylen-Schaum,
für 2-fach-Isolierglas,
Füllelement-Dicken 28-37 mm

VE = 20 m

450.065
Gaine isolante montant
en mousse de polyéthylène,
pour verre isolant double,
épaisseurs d'élément de
remplissage 28-37 mm

UV = 20 m

450.065
Insulating core mullion
made from polyethylene foam,
for double insulating glass,
infill unit thicknesses 28-37 mm

PU = 20 m

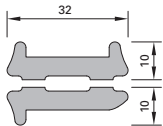

450.066
Dämmprofil Riegel
aus Polyethylen-Schaum,
für 2-fach-Isolierglas,
Füllelement-Dicken 28-37 mm

VE = 20 m

450.066
Gaine isolante traverse
en mousse de polyéthylène,
pour verre isolant double,
épaisseurs d'élément de
remplissage 28-37 mm

UV = 20 m

450.066
Insulating core transom
made from polyethylene foam,
for double insulating glass,
infill unit thicknesses 28-37 mm

PU = 20 m

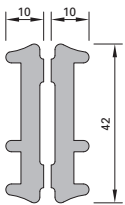

450.067
Dämmprofil Pfosten
aus Polyethylen-Schaum,
für 3-fach-Isolierglas,
Füllelement-Dicken 38-70 mm

VE = 20 m

450.067
Gaine isolante montant
en mousse de polyéthylène,
pour verre isolant triple,
épaisseurs d'élément de
remplissage 38-70 mm

UV = 20 m

450.067
Insulating core mullion
made from polyethylene foam,
for triple insulating glass,
infill unit thicknesses 38-70 mm

PU = 20 m

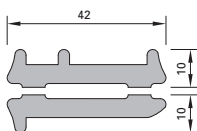

450.068
Dämmprofil Riegel
aus Polyethylen-Schaum,
für 3-fach-Isolierglas,
Füllelement-Dicken 38-70 mm

VE = 20 m

450.068
Gaine isolante transom
en mousse de polyéthylène,
pour verre isolant triple,
épaisseurs d'élément de
remplissage 38-70 mm

UV = 20 m

450.068
Insulating core transom
made from polyethylene foam,
for triple insulating glass,
infill unit thicknesses 38-70 mm

PU = 20 m

Mit U_f -Spitzenwerten bis $0,73 \text{ W/m}^2\text{K}$ setzt die VISS HI-Stahlfassade neue Standards in puncto Wärmedämmung und erreicht dank den innovativen Dämmprofilen Passivhaus bzw. Minergie P-Standard.

Avec des valeurs U_f maximales de $0,73 \text{ W/m}^2\text{K}$, la façade en acier VISS HI établit de nouveaux standards d'isolation thermique et atteint le standard P d'une maison passive et Minergie grâce aux noyaux isolants innovants.

With peak U_f values up to $0.73 \text{ W/m}^2\text{K}$, the VISS HI-steel facade sets new standards in heat insulation and thanks to its innovative insulating cores it reaches the standard of a passive house or the Minergie P standard.

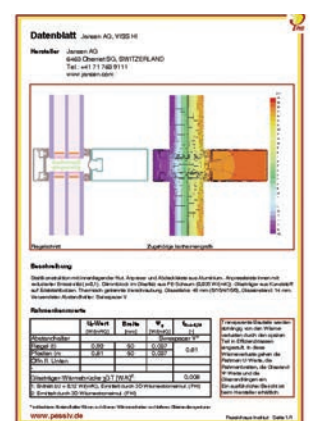

Artikel in Abhängigkeit der
Füllelementstärken

Articles en fonction de l'éléments
de remplissage

Items depending on thickness
of infill elements

	Isolationsknopf Bouton d'isolation Insulating stud 1			Traganker Boulon-support Supporting bolt 2				Falzprofil Profilé de feuillure Rebate section 3						Glasauflage eingeschweisst Support de verre soudé Glazing support welding 4			Tragklotz Cale pour remplissage Glazing support 5					
F mm	452.464	452.465	452.466	452.473	452.469	452.470	452.471	407.809	407.808	407.810	407.811	407.812	407.813	407.814	Flachstahl 100 x 10 mm Acier plat 100 x 10 mm Flat steel 100 x 10 mm	453.013	453.002	453.003	453.004	453.010	453.078	
06 – 11	●			●				●								●					●	
12 – 15	●				●				●												●	
16 – 19	●					●				●											●	
20 – 23	●					●				●							●				●	
24 – 26		●				●					●						●				●	
27 – 30		●					●					●					●				●	
31 – 35		●					●						●				●				●	
36 – 40		●					●							●				●			●	
41 – 45		●													F + 25 mm						●	
46 – 70			●																			●

- optional auch möglich
- aussi possible en option
- optional also possible

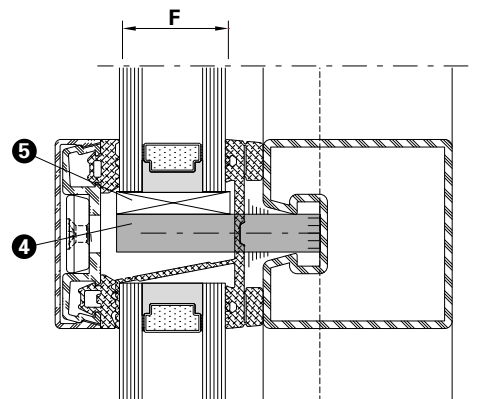
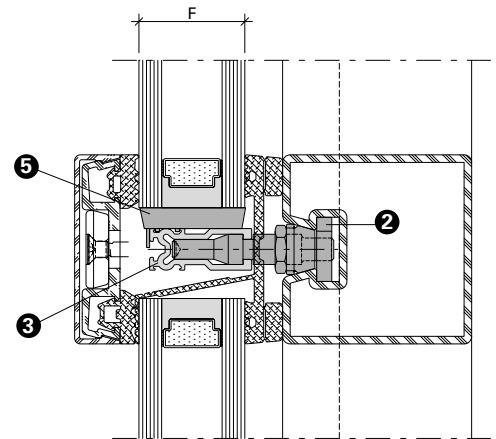
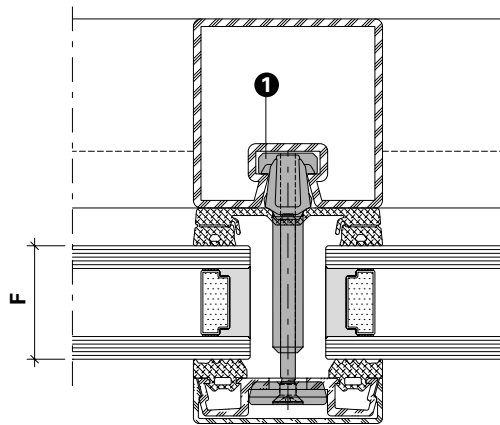
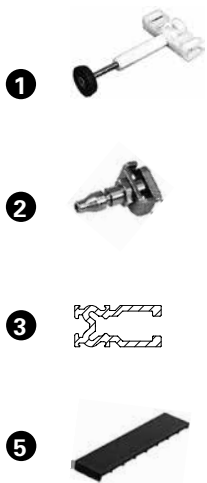

Flaches Deckprofil

Profilé de recouvrement plat

Flat cover cap

Artikel in Abhängigkeit der Füllelementstärken

Articles en fonction de l'éléments de remplissage

Items depending on thickness of infill elements

	Isolationsknopf Bouton d'isolation Insulating stud 1			Traganker Boulon-support Supporting bolt 2			Falzprofil Profilé de feuillure Rebate section 3						Glasauflage eingeschweisst Support de verre soudé Glazing support welding 4			Tragklotz* Cale pour remplissage* Glazing support* 5
F mm	452.410	452.411	452.412	452.469	452.470	452.471	407.808	407.810	407.811	407.812	407.813	407.814	Flachstahl 100 x 10 mm Acier plat 100 x 10 mm Flat steel 100 x 10 mm	453.078		
20 – 24	●			●			●							T = F		
25 – 27	●				●			●								
28 – 31	●				●				●							
32 – 35	●					●				●						
36 – 40		●				●					●					
41 – 45		●				●						●				
46 – 55		●														
56 – 70			●										F + 16 mm			

* Hinweis

Vordere Kante 45° zuschneiden,
Mindestdicke Aussenscheibe 4 mm
(auch im VSG)

* Remarque

Couper l'arrête avant à 45°, épaisseur
minimale de la vitre extérieure 4 mm
(également en VSG)

* Note

Cut front edge at 45°, minimum
thickness of outer pane = 4 mm
(also for LSG)

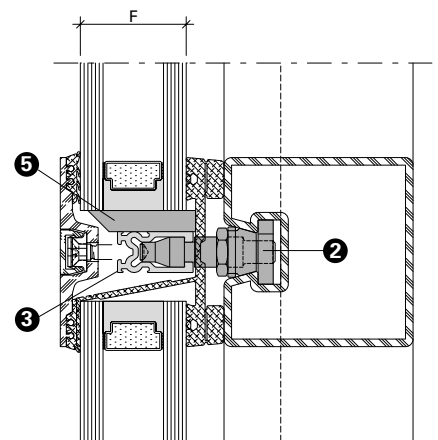
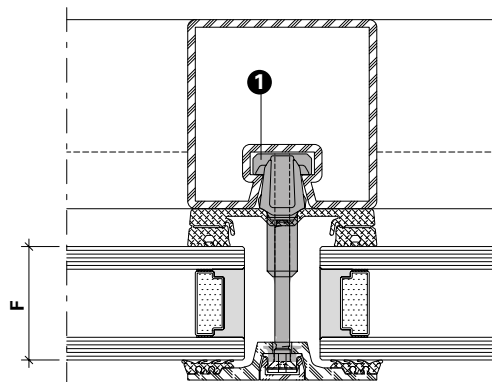
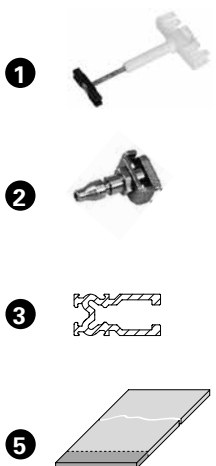



452.464 F = 6 – 23 mm
452.465 F = 24 – 45 mm
452.466 F = 46 – 70 mm

Isolationsknopf

bestehend aus vormontiertem Kunststoff-Drehknopf mit Klemmfeder und Edelstahl-Spezierschraube mit montierter Kunststoff-Zentrierscheibe.

VE = 100 Stück

Einsatz:
siehe Seite 22-16

452.464 F = 6 – 23 mm
452.465 F = 24 – 45 mm
452.466 F = 46 – 70 mm

Bouton d'isolation

composé d'un bouton en matière plastique prémonté et d'une vis spéciale en acier Inox et une rondelle de centrage.

UV = 100 pièces

Utilisation:
voir page 22-16

452.464 F = 6 – 23 mm
452.465 F = 24 – 45 mm
452.466 F = 46 – 70 mm

Insulating stud

comprising pre-assembled plastic turning knob with friction spring and special stainless steel screw with built-in plastic centring disc.

PU = 100 pieces

Application:
see page 22-16



452.473 F = 6 – 11 mm

Traganker

Edelstahl 1.4305, mit vormontiertem Keil und Nutenstein, zum Abtragen der Füllelement-Gewichte.

VE = 20 Stück

Einsatz:
siehe Seite 22-16

452.473 F = 6 – 11 mm

Boulon-support

acier Inox 1.4305, avec cale prémontée et clameau, pour supporter le poids du remplissage.

UV = 20 pièces

Utilisation:
voir page 22-16

452.473 F = 6 – 11 mm

Supporting bolt

stainless steel 1.4305, with pre-assembled key and tenon block, to support weight of infill panel.

PU = 20 pieces

Application:
see page 22-16



452.469 F = 12 – 15 mm
452.470 F = 16 – 26 mm
452.471 F = 27 – 40 mm

Traganker

Edelstahl 1.4305, mit vormontiertem Keil und Nutenstein, zum Abtragen der Füllelement-Gewichte.

VE = 20 Stück

Einsatz:
siehe Seite 22-16/17

452.469 F = 12 – 15 mm
452.470 F = 16 – 26 mm
452.471 F = 27 – 40 mm

Boulon-support

acier Inox 1.4305, avec cale prémontée et clameau, pour supporter le poids du remplissage.

UV = 20 pièces

Utilisation:
voir page 22-16/17

452.469 F = 12 – 15 mm
452.470 F = 16 – 26 mm
452.471 F = 27 – 40 mm

Supporting bolt

stainless steel 1.4305, with pre-assembled key and tenon block, to support weight of infill panel.

PU = 20 pieces

Application:
see page 22-16/17

Auf den folgenden Seiten ergänzen wir ab 2016 das Lieferprogramm mit dem neuen schraubbaren Glasaufleger.

Dans les pages qui suivent, nous compléterons l'assortiment avec des supports de vitrage vissables à partir de 2016.

From 2016, we will supplement the product range on the following pages with the new screw-type glazing support.

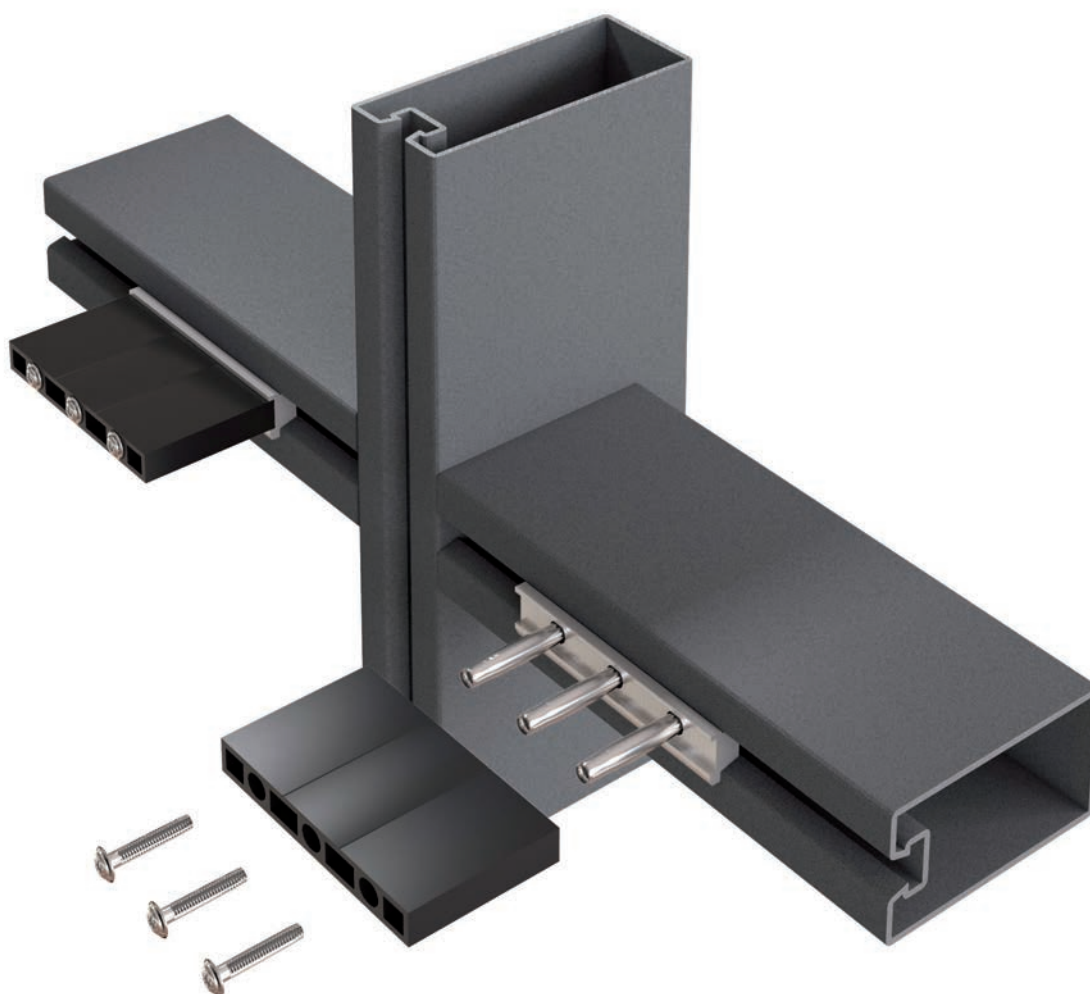

Zubehör
Accessoires
Accessories

VISS Fassade
VISS façade
VISS façade

Flaches Deckprofil

Profilé de recouvrement plat

Flat cover cap



452.410 F = 20 - 39 mm
452.411 F = 36 - 59 mm
452.412 F = 56 - 70 mm

Isolationsknopf
bestehend aus vormontiertem
Kunststoff-Drehknopf mit
Klemmfeder und Edelstahl-
Spezialschraube mit montiertem
Kunststoff-Klemmkopf.

VE = 100 Stück

Einsatz:
Flaches Deckprofil
siehe Seite 22-17

452.410 F = 20 - 39 mm
452.411 F = 36 - 59 mm
452.412 F = 56 - 70 mm

Bouton d'isolation
composé d'un bouton en
matière plastique prémonté
et d'une vis spéciale en acier
Inox avec tête de serrage en
PVC montée.

UV = 100 pièces

Utilisation:
Profilé de recouvrement plat
voir page 22-17

452.410 F = 20 - 39 mm
452.411 F = 36 - 59 mm
452.412 F = 56 - 70 mm

Insulating stud
comprising pre-assembled
plastic turning knob with friction
spring and special stainless
steel screw with mounted
plastic clamping nut.

PU = 100 pieces

Application:
Flat cover cap
see page 22-17



455.528
Aussendichtung
vertikal/horizontal oben
EPDM schwarz

VE = 100 m

Einsatz:
Flaches Deckprofil

455.528
Joint extérieur
vertical/horizontal haut
EPDM noir

UV = 100 m

Utilisation:
Profilé de recouvrement plat

455.528
Outer gasket
vertical/horizontal at the top
EPDM black

PU = 100 m

Application:
Flat cover cap



455.529
Aussendichtung
horizontal unten
EPDM schwarz

VE = 50 m

Einsatz:
Flaches Deckprofil

455.529
Joint extérieur
horizontal bas
EPDM noir

UV = 50 m

Utilisation:
Profilé de recouvrement plat

455.529
Outer gasket
horizontal at the bottom
EPDM black

PU = 50 m

Application:
Flat cover cap

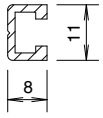

407.809 F = 6 – 11 mm

Falzprofil
Aluminium,
für Glasauflage,
0,113 kg/m

VE = 6 m

Einsatz:
siehe Seite 22-16

407.809 F = 6 – 11 mm

Profilé de feuillure
aluminium,
pour support de verre,
0,113 kg/m

UV = 6 m

Utilisation:
voir page 22-16

407.809 F = 6 – 11 mm

Rebate section
aluminium,
for glazing supports,
0,113 kg/m

PU = 6 m

Application:
see page 22-16

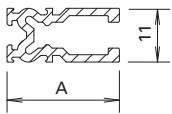

Falzprofil
Aluminium,
für Glasauflage

VE = 6 m

Artikel-Nr.	A mm	kg m	F mm
407.808	18	0,187	12-15
407.810	20	0,230	16-23
407.811	23	0,275	24-26
407.812	27	0,305	27-30
407.813	31	0,338	31-35
407.814	36	0,374	36-40

Einsatz:
siehe Seite 22-16/17

Profilé de feuillure
aluminium,
pour support de verre

UV = 6 m

No d'article	A mm	kg m	F mm
407.808	18	0,187	12-15
407.810	20	0,230	16-23
407.811	23	0,275	24-26
407.812	27	0,305	27-30
407.813	31	0,338	31-35
407.814	36	0,374	36-40

Utilisation:
voir page 22-16/17

Rebate section
aluminium,
for glazing supports

PU = 6 m

Code no.	A mm	kg m	F mm
407.808	18	0,187	12-15
407.810	20	0,230	16-23
407.811	23	0,275	24-26
407.812	27	0,305	27-30
407.813	31	0,338	31-35
407.814	36	0,374	36-40

Application:
see page 22-16/17

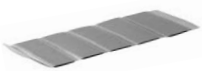

455.423 50 mm
455.424 60 mm

Butyl-Dichtstück
zum Abdichten der Kreuz- und
Endpunkte der Innendichtungen.

VE = 50 Stück

455.423 50 mm
455.424 60 mm

Pièce de butyl
pour étancher les points de
croisée et les points T des joints
intérieurs.

UV = 50 pièces

455.423 50 mm
455.424 60 mm

Butyl sealing strip
for sealing the intersecting and
end points of the inner gaskets.

PU = 50 pieces

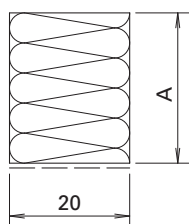

**Ausgleichsprofil für
Wandanschluss**
aus Polystyrol-Hartschaum,
einseitig mit Kleber und
Schutzfolie.

VE = 20 Stück à 1250 mm

Profils de compensation
en mousse rigide de
polystyrène, une face adhésive
avec feuille de protection

UV = 20 pièces à 1250 mm

**Compensating section for
wall abutment**
rigid expanded polystyrene,
with adhesive and protective
film on one side

PU = 20 pieces, 1250 mm each

Artikel-Nr.	A mm
452.310	10
452.311	20
452.312	22
452.313	24
452.314	26
452.315	28
452.316	30

No d'article	A mm
452.310	10
452.311	20
452.312	22
452.313	24
452.314	26
452.315	28
452.316	30

Code no.	A mm
452.310	10
452.311	20
452.312	22
452.313	24
452.314	26
452.315	28
452.316	30



453.013 F = 6 - 11 mm

Tragklotz
PE schwarz, 80/8/6,
selbstklebend

VE = 50 Stück

Einsatz:
siehe Seite 22-16

453.013 F = 6 - 11 mm

Cale pour remplissage
PE noir, 80/8/6,
autocollante

UV = 50 pièces

Utilisation:
voir page 22-16

453.013 F = 6 - 11 mm

Glazing support
PE black, 80/8/6,
self adhesive

PU = 50 pieces

Application:
see page 22-16



453.002 F = 20 - 26 mm

453.003 F = 27 - 30 mm

453.004 F = 31 - 35 mm

453.010 F = 36 - 40 mm

Tragklotz
GFK-PA schwarz

VE = 50 Stück

Einsatz:
siehe Seite 22-16

453.002 F = 20 - 26 mm

453.003 F = 27 - 30 mm

453.004 F = 31 - 35 mm

453.010 F = 36 - 40 mm

Cale pour remplissage
GFK-PA noir

UV = 50 pièces

Utilisation:
voir page 22-16

453.002 F = 20 - 26 mm

453.003 F = 27 - 30 mm

453.004 F = 31 - 35 mm

453.010 F = 36 - 40 mm

Glazing support
GFK-PA black

PU = 50 pieces

Application:
see page 22-16

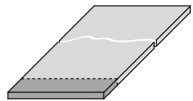

453.078

Tragklotz
PE schwarz, 80 x 6 mm,
zum selber Zuschneiden

VE = 1 Stück à 1000 mm

Einsatz:
siehe Seite 22-16/17

453.078

Cale pour remplissage
PE noir, 80 x 6 mm,
à découper soi-même

UV = 1 pièce à 1000 mm

Utilisation:
voir page 22-16/17

453.078

Glazing support
PE black, 80 x 6 mm,
to be cut by customer

PU = 1 piece, 1000 mm each

Application:
see page 22-16/17

**Sonderkonstruktion mit sichtbar
verschraubter Deckleiste**

**Construction spéciale avec profilé
de recouvrement vissé visible**

**Special construction using a
visible screw-affixed cover section**



452.467

Klemm-Isolationsknopf
bestehend aus vormontiertem
Kunststoff-Drehknopf mit Edel-
stahlknopf und Klemmfeder

VE = 50 Stück

452.467

Bouton-pression d'isolation
composé d'un bouton matière
plastique prémonté avec tête en
acier Inox et ressort de serrage.

UV = 50 pièces

452.467

Insulating coupling stud
comprising plastic turning knob
with stainless steel button and
clamp spring

PU = 50 pieces



452.494

**Edelstahl-SR1-Selbstbohr-
schraube ø 3,9 x 20 mm**
für Abdeckprofile 407.858
und 407.859

VE = 100 Stück

452.494

**Vis autoforeuse acier Inox-SR1
ø 3,9 x 20 mm**
pour profilés de recouvrement
407.858 et 407.859

UV = 100 pièces

452.494

**Stainless steel SR1 self-cutting
screw ø 3,9 x 20 mm**
for cover sections 407.858 and
407.859

PU = 100 pieces



452.495

**Edelstahl-SR1-Selbstbohr-
schraube ø 3,9 x 31,5 mm**
für Abdeckprofile 407.858
und 407.859

VE = 100 Stück

452.495

**Vis autoforeuse acier Inox-SR1
ø 3,9 x 31,5 mm**
pour profilés de recouvrement
407.858 et 407.859

UV = 100 pièces

452.495

**Stainless steel SR1 self-cutting
screw ø 3,9 x 31,5 mm**
for cover sections 407.858 and
407.859

PU = 100 pieces



550.378

Edelstahl-Selbstbohrschraube
4,8x29 mm, mit Innen-Sechs-
kant, für Abdeckprofile 407.817
und 407.818

VE = 100 Stück

550.378

Vis autoforeuse acier Inox
4,8x29 mm, avec six pans creux,
pour profilés de recouvrement
407.817 et 407.818

UV = 100 pièces

550.378

**Stainless steel self-cutting
screw**
4,8x29 mm, hexagon socket
head, for cover sections 407.817
and 407.818

PU = 100 pieces



**Ankerteil für
Sonnenschutz-Befestigung**
Edelstahl, mit vormontiertem
Aluminium-Keil und Nutenstein

VE = 10 Stück

Artikel-Nr.	Länge
452.550	9 mm
452.551	17 mm
452.552	23 mm
452.553	30 mm
452.554	35 mm
452.555	42 mm
452.556	55 mm

Einsatz:
siehe Seiten 22-74/75

**Boulon d'ancrage
pour fixation pare-soleil**
acier Inox, avec cale prémontée
en aluminium et clameau

UV = 10 pièces

No d'article	Longueur
452.550	9 mm
452.551	17 mm
452.552	23 mm
452.553	30 mm
452.554	35 mm
452.555	42 mm
452.556	55 mm

Utilisation:
voir pages 22-74/75

**Anchor for fastening
of sun protection**
stainless steel, with pre-
assembled aluminium key and
tenon block

PU = 10 pieces

Code no.	Length
452.550	9 mm
452.551	17 mm
452.552	23 mm
452.553	30 mm
452.554	35 mm
452.555	42 mm
452.556	55 mm

Application:
see pages 22-74/75



452.557
**Aufsatzbolzen für
Sonnenschutz-Befestigung**
Edelstahl, mit vormontiertem
M4-Gewindestift und EPDM-
Dichtscheibe, zum Aufsetzen
auf Befestigungsanker
452.550-452.556.

VE = 10 Stück

Einsatz:
siehe Seiten 22-74/75

452.557
**Boulon de fixation pour
fixation pare-soleil**
acier Inox, avec taraudage M4
et rondelle d'étanchéité EPDM,
à poser sur boulon d'ancrage
452.550-452.556.

UV = 10 pièces

Utilisation:
voir pages 22-74/75

452.557
**Bolt for fastening
of sun protection**
stainless steel, with pre-
assembled M4 threaded pin
and EPDM seal washer, to
be fitted onto fastening
anchor 452.550-452.556.

PU = 10 pieces

Application:
see pages 22-74/75



450.092

Kleb- und Dichtmasse

schwarz, für das Abdichten der Dichtungs-Stösse und -Durchbrüche

VE = 1 Kartusche 290 ml

Wichtig:

Ohne Vorbehandlung mit Reiniger 450.091 ist die Klebehaftung nicht gewährleistet.

450.092

Pâte à coller et à étancher

noire, pour étancher les raccords et les points de raccords des joints intérieurs

UV = 1 cartouche 290 ml

Important:

Sans traitement préliminaire avec un nettoyant 450.091, l'adhésion n'est pas garantie.

450.092

Sealing and bonding compound

black, for sealing the joints and holes in the weatherstrip

PU = 1 cartridge 290 ml

Important:

Adhesion cannot be guaranteed unless cleaner 450.091 has been used as a pre-treatment.



450.091

Reiniger

zur Reinigung aller Teile vor dem Anbringen der Dichtmasse

VE = 1 Liter

450.091

Nettoyant

pour nettoyer toutes les pièces avant d'appliquer la pâte à étancher

UV = 1 litre

450.091

Cleaner

for cleaning all components before applying the sealing compound

PU = 1 litre



450.106

Dichtmasse

transparent, Silikon dünnflüssig, für Abdichtungen von kleinen Fugen, inkl. Ausspritzdüsen

VE = 2 Kartuschen 310 ml

450.106

Pâte d'étanchéité

transparente, silicone fluide, pour étanchéification de petits joints, avec gicleurs d'éjection

UV = 2 cartouches de 310 ml

450.106

Sealing compound

transparent, thin silicone, for sealing small joints, includes spray nozzles

PU = 2 cartridges 310 ml



455.495 40 x 0,8 mm

455.496 50 x 0,8 mm

Butyl-Dichtband, alukaschiert

flexibel, dampfdicht, selbstklebend

VE = 2 Rollen à 20 m

455.495 40 x 0,8 mm

455.496 50 x 0,8 mm

Bande butyl, doublée d'aluminium

autocollante, flexible, étanche à la vapeur

UV = 2 rouleaux à 20 m

455.495 40 x 0,8 mm

455.496 50 x 0,8 mm

Butyl sealing strip, aluminium-laminated

flexible, damp-proof, self adhesive

PU = 2 rollers 20 m each

**Dichtungen VISS TV
(Variante)**

**Joints VISS TV
(Variante)**

**Gaskets VISS TV
(Variante)**



455.513

Innendichtung vertikal
50 mm breit, EPDM schwarz

VE = 50 m

455.513

Joint intérieur vertical
largeur 50 mm, EPDM noir

UV = 50 m

455.513

Inner gasket, vertical
50 mm wide, EPDM black

PU = 50 m

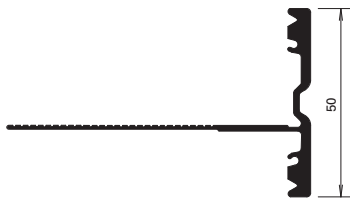

455.555

Innendichtung horizontal
50 mm breit, EPDM schwarz

VE = 50 m

455.555

Joint intérieur horizontal
largeur 50 mm, EPDM noir

UV = 50 m

455.555

Inner gasket, horizontal
50 mm wide, EPDM black

PU = 50 m

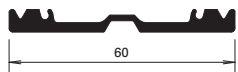

455.514

Innendichtung vertikal
60 mm breit, EPDM schwarz

VE = 50 m

455.514

Joint intérieur vertical
largeur 60 mm, EPDM noir

UV = 50 m

455.514

Inner gasket, vertical
60 mm wide, EPDM black

PU = 50 m



455.556

Innendichtung horizontal
60 mm breit, EPDM schwarz

VE = 50 m

455.556

Joint intérieur horizontal
largeur 60 mm, EPDM noir

UV = 50 m

455.556

Inner gasket, horizontal
60 mm wide, EPDM black

PU = 50 m

**Dichtungen VISS TV
(Variante)**

**Joints VISS TV
(Variante)**

**Gaskets VISS TV
(Variante)**



455.501

Aussendichtung
für Anpressprofile,
EPDM schwarz

VE = 100 m

Einsatz:
Pfosten, Riegel oben

455.501

Joint extérieur
pour profilé de fixation,
EPDM noir

UV = 100 m

Utilisation:
Montant, traverse supérieur

455.501

Outer gasket
for clamping sections,
EPDM black

PU = 100 m

Application:
Mullion, transom top



455.502

Aussendichtung
für Anpressprofile,
EPDM schwarz

VE = 50 m

Einsatz:
Riegel unten

455.502

Joint extérieur
pour profilé de fixation,
EPDM noir

UV = 50 m

Utilisation:
Traverse inférieur

455.502

Outer gasket
for clamping sections,
EPDM black

PU = 50 m

Application:
Transom bottom



452.499

Entspannungsstück
Kunststoff schwarz

VE = 100 Stück

Einsatz:
Riegel unten, als Entspannungs-
und Entwässerungsöffnung
(Dichtung 455.502)

452.499

Pièce de décompression
matière plastique noire

UV = 100 pièces

Utilisation:
Traverse inférieure,
pour l'aération et l'écoulement
(joint 455.502)

452.499

Stress relieving block
plastic, black

PU = 100 pieces

Application:
Transom bottom,
for stress relieving and drainage
opening (gasket 455.502)

Dichtungen VISS TV (Variante)

Artikel in Abhängigkeit der
Füllelementstärken

Joints VISS TV (Variante)

Articles en fonction de l'éléments
de remplissage

Gaskets VISS TV (Variante)

Items depending on thickness
of infill elements

	Isolationsknopf Bouton d'isolation Insulating stud 1			Traganker Boulon-support Supporting bolt 2				Falzprofil Profilé de feuillure Rebate section 3					Glasauflage eingeschweisst Support de verre soudé Glazing support welding	Tragklotz Cale pour remplissage Glazing support 4						
F mm	452.464	452.465	452.466	452.473	452.469	452.470	452.471	407.809	407.808	407.810	407.811	407.812	407.813	Flachstahl 100 x 10 mm Acier plat 100 x 10 mm Flat steel 100 x 10 mm	453.013	453.002	453.003	453.004	453.010	453.078
06 – 12	●			●				●							●					●
13 – 14	●			●				●												●
15 – 19	●				●				●											●
20 – 26	●					●				●						●				●
27 – 30		●				●					●						●			●
31 – 35		●					●					●					●			●
36 – 40		●					●						●					●		●
41 – 50		●												F + 21 mm					●	●
51 – 70			●																	●

- optional auch möglich
- aussi possible en option
- optional also possible

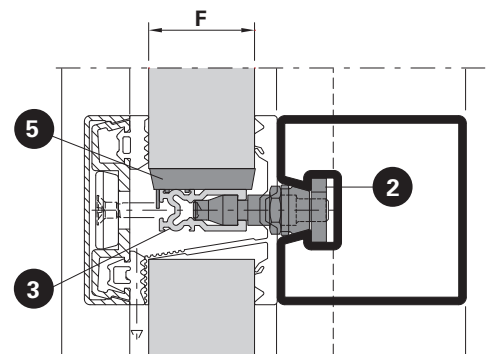
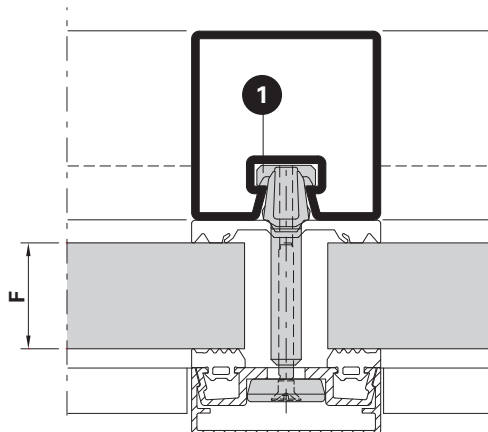
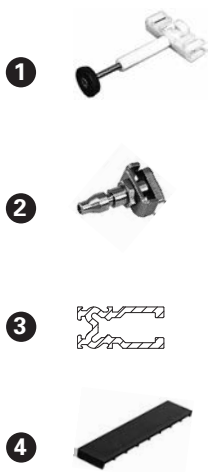

Dichtungen VISS TV (Variante)

Flaches Deckprofil

Artikel in Abhängigkeit der
Füllelementstärken

Jointts VISS TV (Variante)

Profilé de recouvrement plat

Articles en fonction de l'éléments
de remplissage

Gaskets VISS TV (Variante)

Flat cover cap

Items depending on thickness
of infill elements

	Isolationsknopf Bouton d'isolation Insulating stud 1			Traganker Boulon-support Supporting bolt 2			Falzprofil Profilé de feuillure Rebate section 3						Glasauflage eingeschweisst Support de verre soudé Glazing support welding	Tragklotz* Cale pour remplissage* Glazing support* 4
F mm	452.410	452.411	452.412	452.469	452.470	452.471	407.808	407.810	407.811	407.812	407.813	407.814	Flachstahl 100 x 10 mm Acier plat 100 x 10 mm Flat steel 100 x 10 mm	453.078
25 – 28	●			●			●							T = F
29 – 31	●				●			●						
32 – 35	●				●				●					
36 – 39	●					●				●				
40 – 44		●				●					●			
45 – 49		●				●						●		
50 – 59		●												
60 – 70			●										F + 12 mm	

*** Hinweis**

Vordere Kante 45° zuschneiden,
Minstdicke Aussenscheibe 4 mm
(auch im VSG)

*** Remarque**

Couper l'arrête avant à 45°, épaisseur
minimale de la vitre extérieure 4 mm
(également en VSG)

*** Note**

Cut front edge at 45°, minimum
thickness of outer pane = 4 mm
(also for LSG)

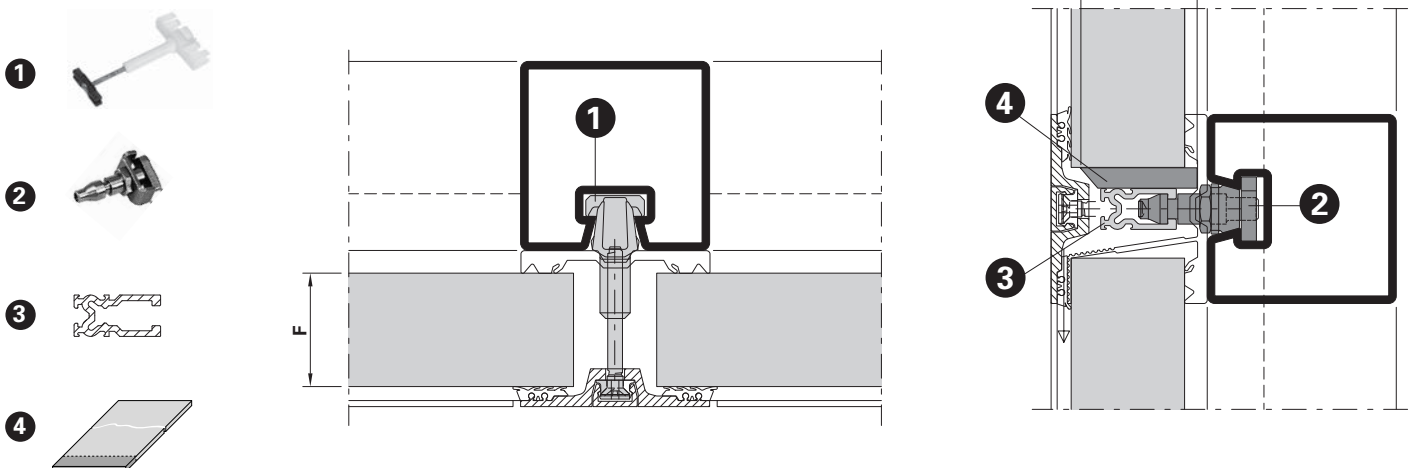

Verarbeitungshilfen

Outils d'usinage

Assembly tools

VISS Fassade

VISS façade

VISS façade



499.003

Schraubklingen
mit SR1-Angriff

VE = 3 Stück

499.003

Embout de tournevis
avec tête spéciale SR1

UV = 3 pièces

499.003

Blades
for SR1-head screws

PU = 3 pieces



499.254

Werkzeugset

VE = 1 Steckschlüssel SW 11
1 Positionierhilfe 25 mm
1 Positionierhilfe 32 mm

499.254

Jeu d'outils

UV = 1 clé à pipe SW 11
1 aide de réglage 25 mm
1 aide de réglage 32 mm

499.254

Tool kit

PU = 1 box spanner size 11
1 positioning aid 25 mm
1 positioning aid 32 mm



499.206

Abziehhebel
für die Demontage der
aufgeklipsten Abdeckprofile

VE = 1 Stück

499.206

Levier de démontage
pour le démontage des profilés
de recouvrement clipsés

UV = 1 pièce

499.206

Stripping lever
for disassembly of the clipped
on cover profile

PU = 1 piece



499.263

Dichtungsschere Kreuzpunkt
zum Ausklinken der vertikalen
Innendichtung

VE = 1 Stück

499.263

**Ciseaux à joints point
d'intersection**
pour entailler le joint intérieur
vertical

UV = 1 pièce

499.263

**Gasket shears for the
intersection point**
for notching the vertical
inner gasket

UV = 1 piece

Verlangen Sie für die
Verarbeitung und Montage
der VISS-Systeme unsere
ausführlichen Verarbeitungs-
und Montage-Richtlinien.

Demandez notre brochure
détaillée sur les directives
d'usinage et de montage
du systèmes VISS.

For processing and assembling
the VISS systems, ask for our
detailed Fabrication and
Assembly Instructions.



499.264

Dichtungsschere Endpunkt
zum Ausklinken der horizontalen
Innendichtung

VE = 1 Stück

499.264

Ciseaux à joints extrémité
pour entailler le joint intérieur
horizontal

UV = 1 pièce

499.264

Gasket shears for the end point
for notching the horizontal inner
gasket

PU = 1 piece



499.266

Dichtungsstanze
zum Ausklinken der
horizontalen Innendichtung

VE = 1 Stück

499.266

Poinçon à joints
pour entailler le joint intérieur
horizontal

UV = 1 pièce

499.266

Gasket punch
for notching the horizontal
inner gasket

PU = 1 piece

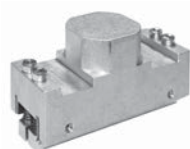

499.267

Austauschset
Das Austauschset ermöglicht das
Aufrüsten der alten Dichtungs-
stanze 499.253 auf den Stand der
neuen Dichtungsstanze 499.266.
Die Adaption beinhaltet einen
Auswurfmechanismus für die
Dichtung sowie einen Schnittschutz.

VE = 1 Stück

499.267

Kit de remplacement
Le kit de remplacement permet
de remplacer l'ancien poinçon
à joints 499.253 par le nouveau
poinçon à joints 499.266. L'adap-
tation comprend un mécanisme
d'éjection du joint ainsi qu'une
protection anticoupures.

UV = 1 pièce

499.267

Replacement kit
The replacement kit allows the
old gasket punch 499.253 to be
upgraded to the standard of the
new gasket punch 499.266. The
adaptation includes an ejection
mechanism for the gasket and
cut protection.

PU = 1 piece



499.262

Ausstanzset
zum Ausklinken der horizontalen
Innendichtung für Flachstahl-
Glasauflagen.

VE = 1 Stück

499.262

Kit de découpage
pour entailler le joint intérieur
horizontal des supports de
vitrage en acier plat.

UV = 1 pièce

499.262

Punching kit
for notching the horizontal
inner gasket for flat steel
glazing supports.

PU = 1 piece

Schnittpunkte	Coupe de détails	Section details	
Pfosten/Riegel-Details 50 mm	Détails montant/traverse 50 mm	Details mullion/transom 50 mm	36
Segment-Verglasung 50 mm	Vitrage segmenté 50 mm	Segmental glazing 50 mm	41
VISS Linea 50 mm	VISS Linea 50 mm	VISS Linea 50 mm	42
Flaches Deckprofil 50 mm	Profilé de recouvrement plat 50 mm	Flat cover cap 50 mm	44
VISS Linea 50 mm	VISS Linea 50 mm	VISS Linea 50 mm	45
Einfachverglasung 50 mm	Vitrage simple 50 mm	Single glazing 50 mm	46
Pfosten/Riegel-Details 60 mm	Détails montant/traverse 60 mm	Details mullion/transom 60 mm	47
VISS Delta 60 mm	VISS Delta 60 mm	VISS Delta 60 mm	51
Segment-Verglasung 60 mm	Vitrage segmenté 60 mm	Segmental glazing 60 mm	53
Flaches Deckprofil 60 mm	Profilé de recouvrement plat 60 mm	Flat cover cap 60 mm	54
Einfachverglasung 60 mm	Vitrage simple 60 mm	Single glazing 60 mm	55

Konstruktions-Details	Détails de constructions	Construction details	
Einsatzelement Janisol HI	Elément de remplissage Janisol HI	Infill element Janisol HI	56
Einsatzelement Janisol-Türe	Elément de remplissage porte Janisol	Infill element Janisol door	57
Einsatzelement Janisol Primo	Elément de remplissage Janisol Primo	Infill element Janisol Primo	58
Aussenecke 90°	Angle extérieur 90°	Outer corner 90°	59
Aussenecke 135°	Angle extérieur 135°	Outer corner 135°	61
Innenecke 135°	Angle intérieur 135°	Inner corner 135°	62
Anschlüsse am Bau			63
	Raccords au mur	Attachment to structure	
Verarbeitungs-Hinweise			
	Indications d'usage	Assembly instructions	
Sonnenschutz-Befestigung	Fixation pare-soleil	Sun protection fixation	72
Stossausbildungen Innendichtung	Jonctions joint intérieur	Inner gasket junctions	74
Glaseinstand	Prise en feuillure	Glass edge cover	76
System-Hinweise			
	Indications du système	System instructions	
Glasfalz-Belüftung und Glasfalz-Entwässerung	Ventilation de feuillures de verre et Drainage de la feuillure à verre	Glazing rebate ventilation and Glazing rebate drainage	78
U _f -Werte nach EN 10077-2	Valeurs U _f selon EN 10077-2	U _f values according to EN 10077-2	80

Schnittpunkte im Massstab 1:1
Coupe de détails à l'échelle 1:1
Section details on scale 1:1

VISS Fassade
VISS façade
VISS façade

VISS HI
Pfosten-Detail
Ansichtsbreite 50 mm

VISS HI
Détail du montant
Largeur de face 50 mm

VISS HI
Detail of mullion
Width 50 mm

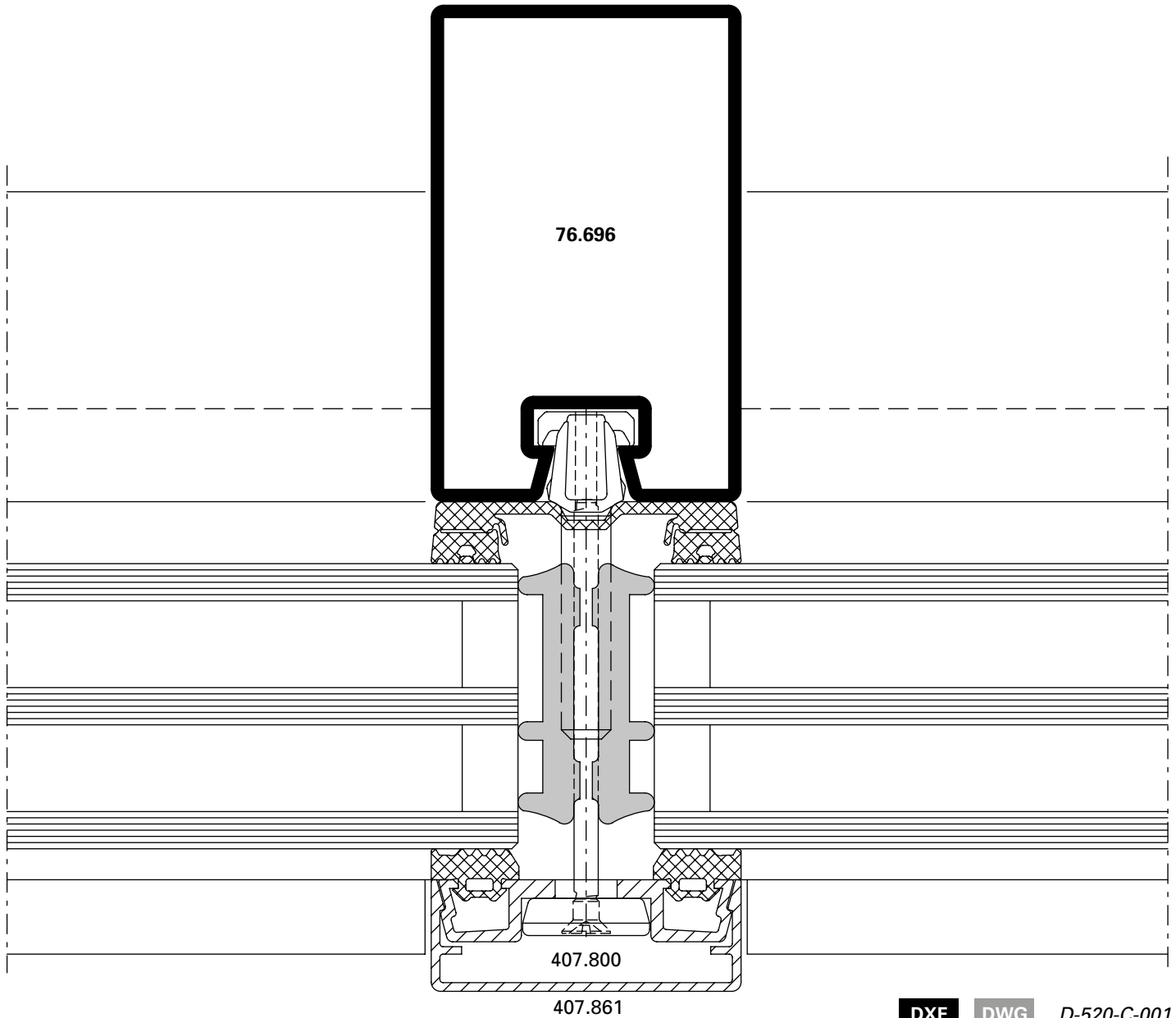

DXF **DWG** D-520-C-001

U_f-Werte siehe ab Seite 22-82

Valeurs U_f voir à partir de page 22-82

U_f values see from page 22-82

Schnittpunkte im Masstab 1:1
Coupe de détails à l'échelle 1:1
Section details on scale 1:1

VISS Fassade
VISS façade
VISS façade

VISS HI
Riegel-Detail
Ansichtsbreite 50 mm

VISS HI
Détail de la traverse
Largeur de face 50 mm

VISS HI
Detail of transom
Width 50 mm

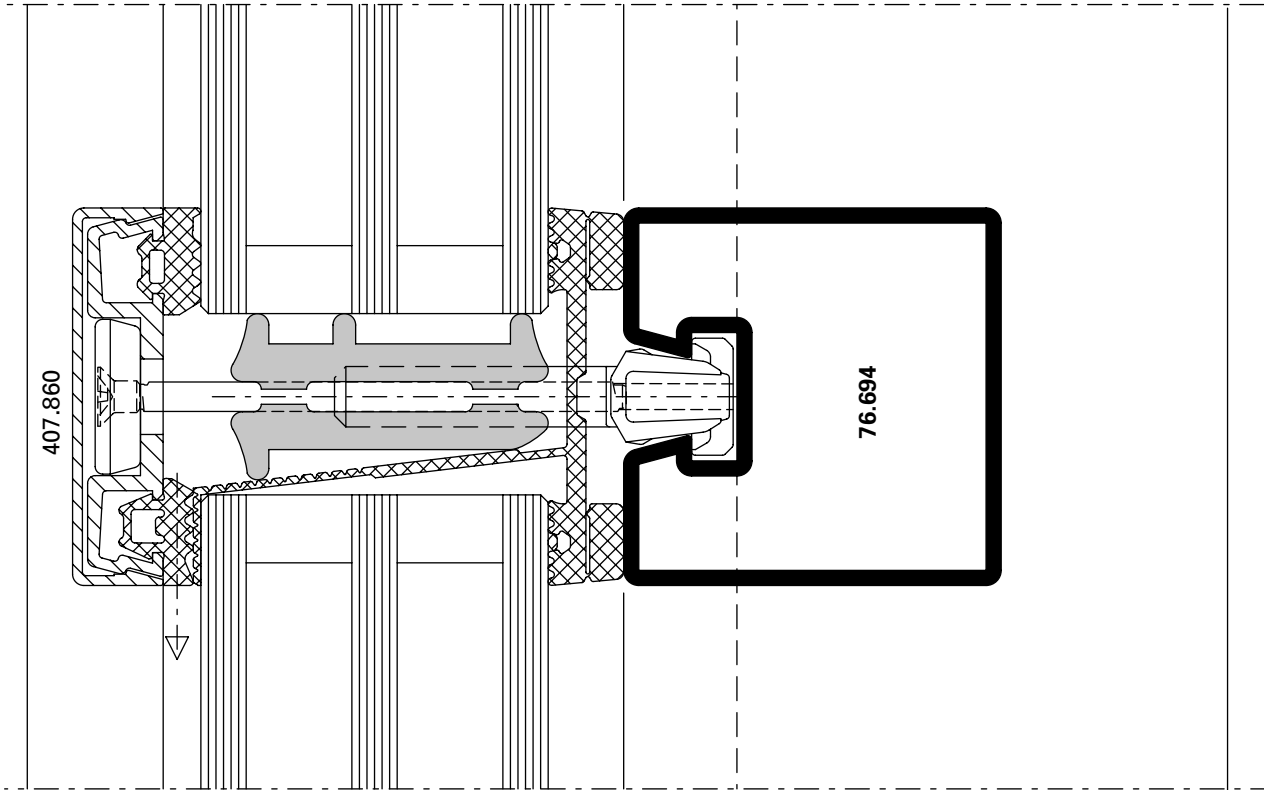

D-520-C-002

DWG

DXF

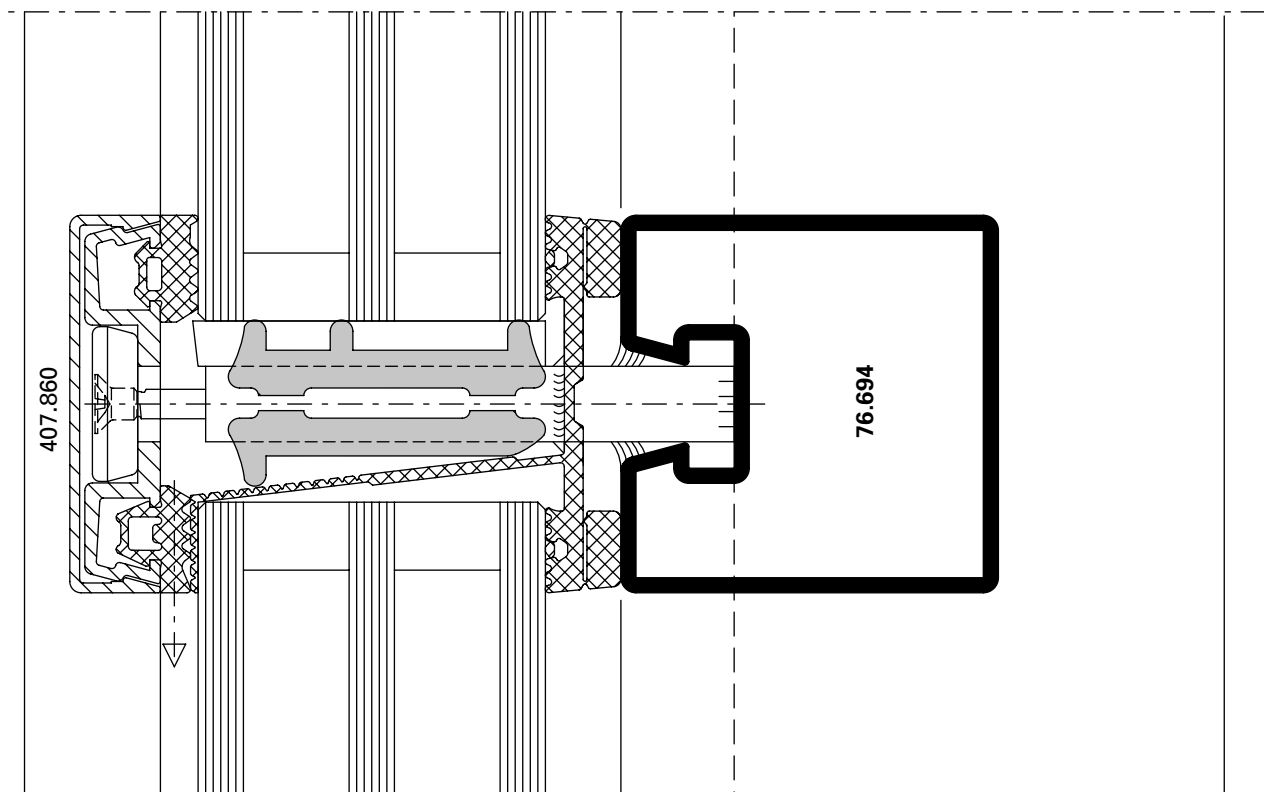

D-520-C-003

DWG

DXF

Schnittpunkte im Massstab 1:1
Coupe de détails à l'échelle 1:1
Section details on scale 1:1

VISS Fassade
VISS façade
VISS façade

Pfosten-Detail
Ansichtsbreite 50 mm

Détail du montant
Largeur de face 50 mm

Detail of mullion
Width 50 mm

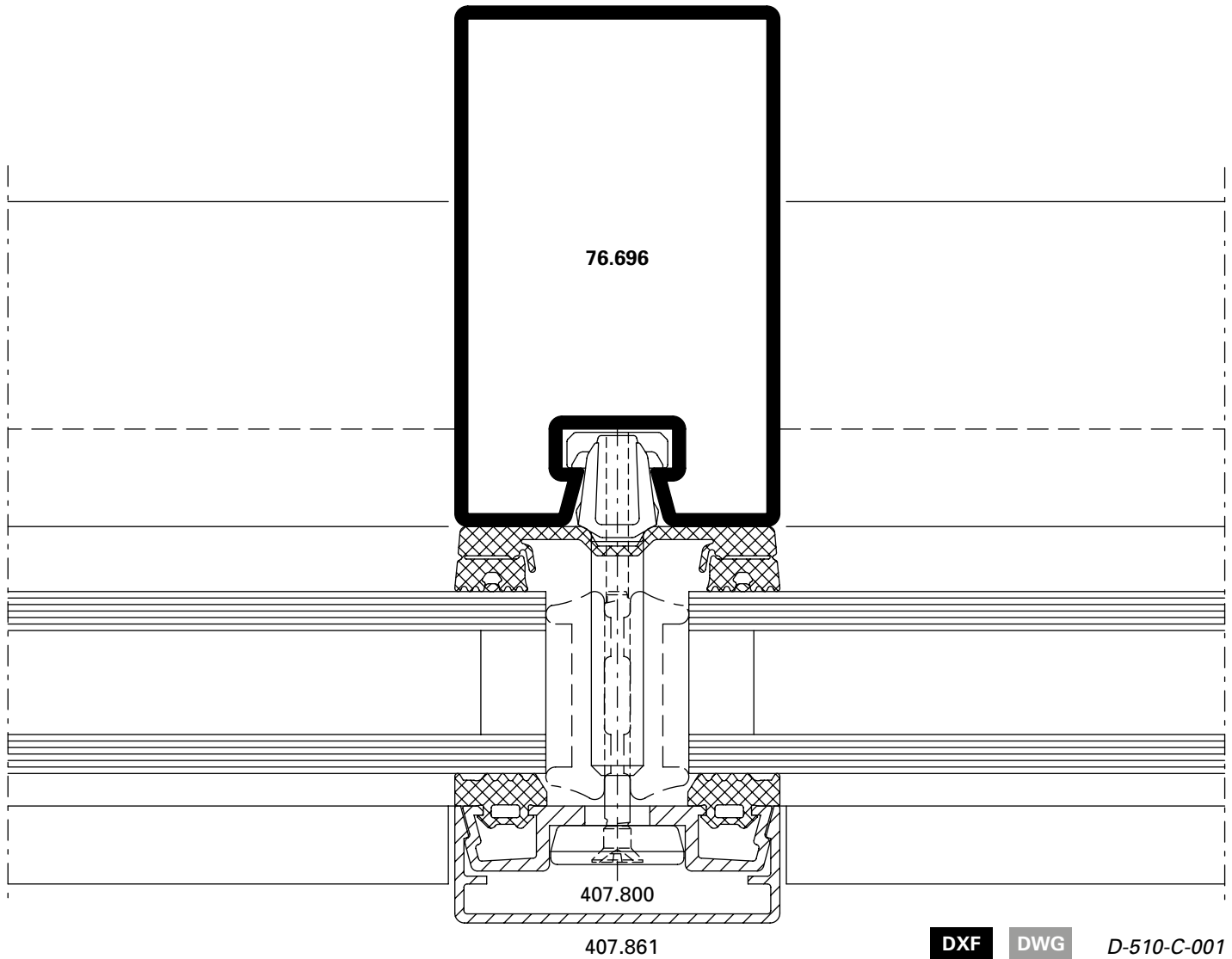

DXF

DWG

D-510-C-001

U_f-Werte siehe ab Seite 22-82

Valeurs U_f voir à partir de page 22-82

U_f values see from page 22-82

Riegel-Detail
Ansichtsbreite 50 mm

Détail de la traverse
Largeur de face 50 mm

Detail of transom
Width 50 mm

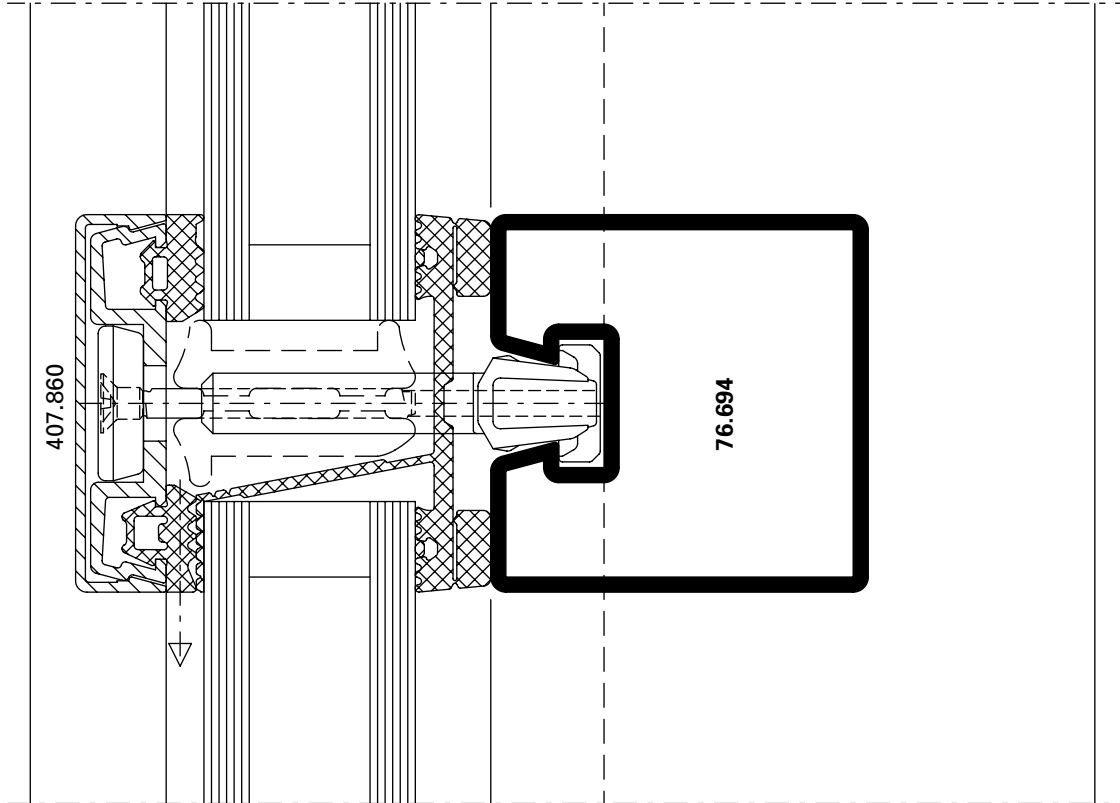

D-510-C-002

DWG

DXF

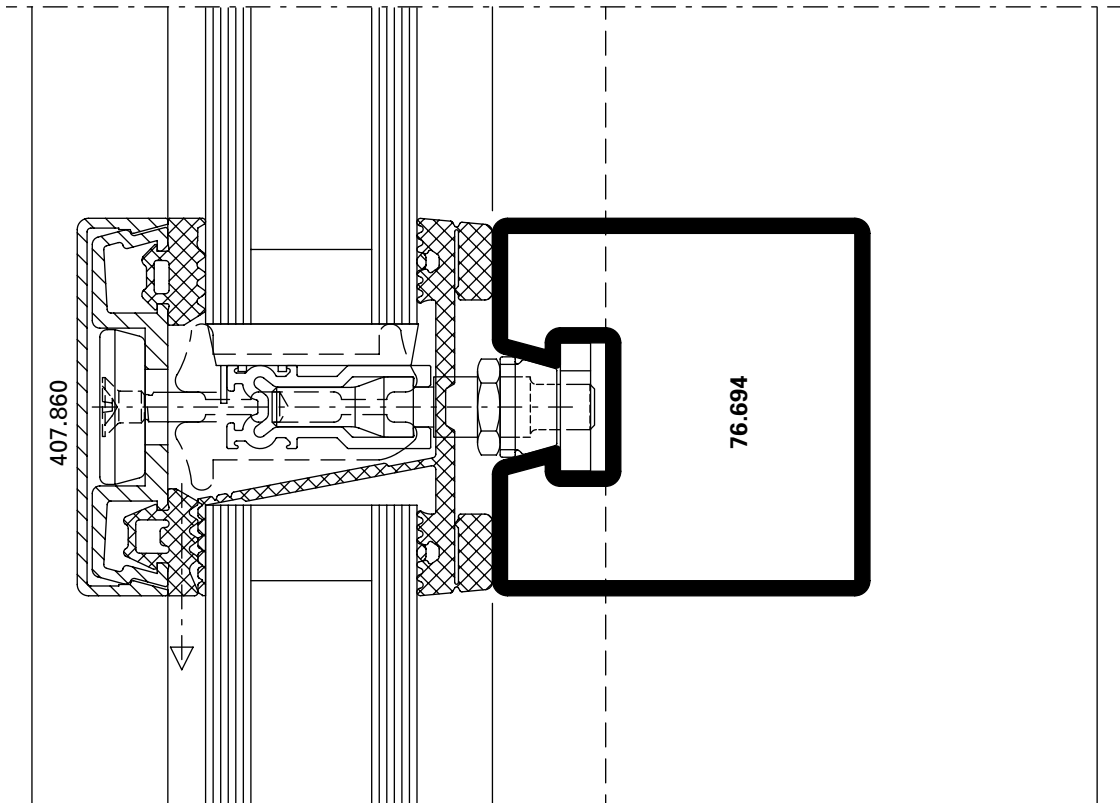

D-510-C-003

DWG

DXF

Pfosten-Detail*
Ansichtsbreite 50 mm

Détail du montant*
Largeur de face 50 mm

Detail of mullion*
Width 50 mm

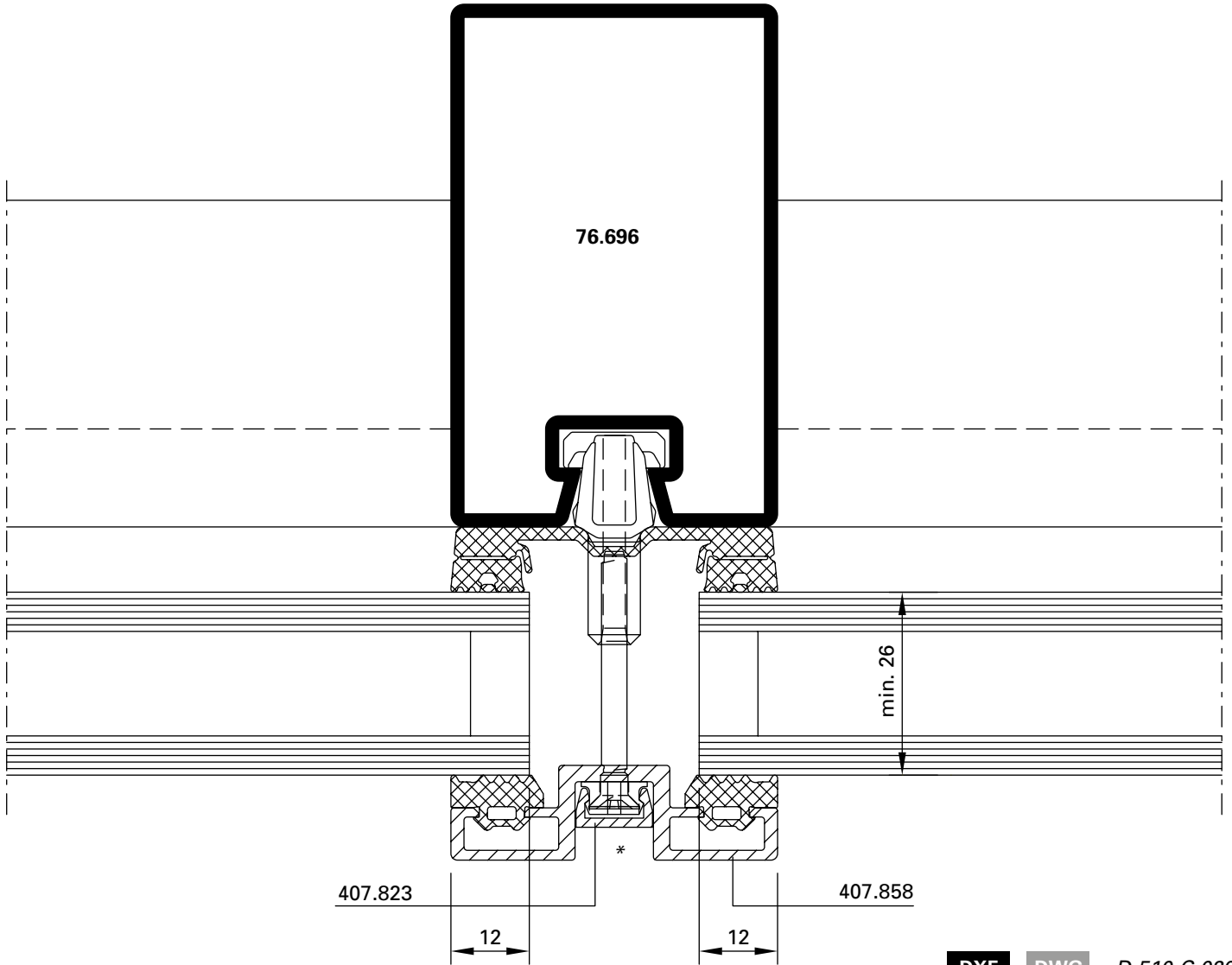

* Sonderkonstruktion
(nach Produktnorm EN 13830
nicht geprüft)

* Construction spéciale
(non contrôlé selon la norme
produit EN 13830)

* Special construction
(Not tested in accordance with the
EN 13830 product standard)

Schnittpunkte im Massstab 1:1
 Coupe de détails à l'échelle 1:1
 Section details on scale 1:1

VISS Fassade
 VISS façade
 VISS façade

Pfosten-Detail
 Segmentverglasung 50 mm

Détail du montant
 Vitrage segmenté 50 mm

Detail of mullion
 Segmental glazing, width 50 mm

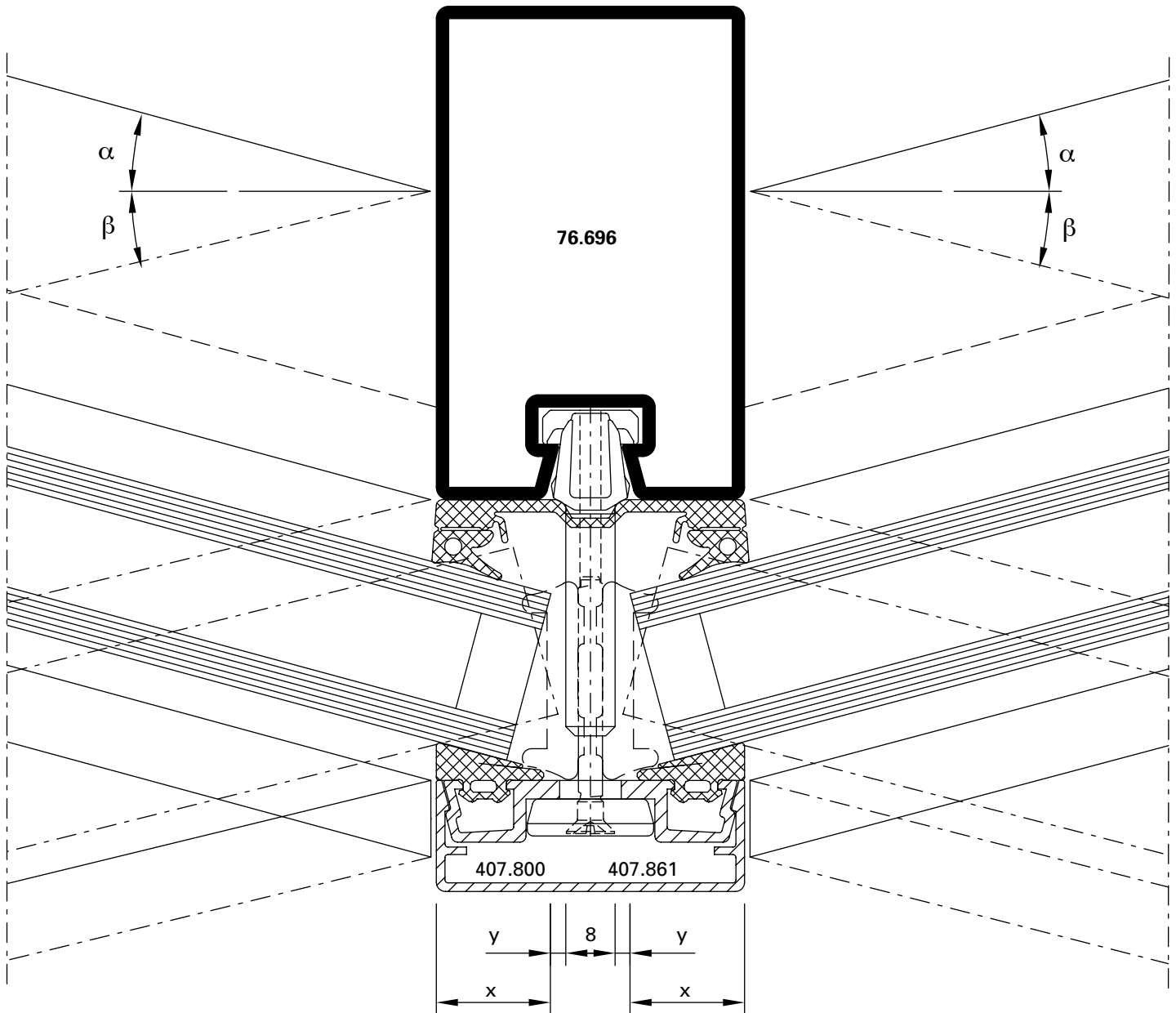

DXF DWG D-510-C-004

α	β	Füllelement- dicke	X (max) mm	Y (min) mm
0 – 5°		20 – 45 mm	16	5
	5 – 10°	20 – 35 mm	18	3
	10 – 15°	20 – 24 mm	18	3

α	β	Epaisseur du remplissage	X (max) mm	Y (min) mm
0 – 5°		20 – 45 mm	16	5
	5 – 10°	20 – 35 mm	18	3
	10 – 15°	20 – 24 mm	18	3

α	β	Thickness of glass/panel	X (max) mm	Y (min) mm
0 – 5°		20 – 45 mm	16	5
	5 – 10°	20 – 35 mm	18	3
	10 – 15°	20 – 24 mm	18	3

Schnittpunkte im Massstab 1:1
Coupe de détails à l'échelle 1:1
Section details on scale 1:1

VISS Fassade
VISS façade
VISS façade

Pfosten-Detail VISS Linea
Ansichtsbreite 50 mm

Détail du montant VISS Linea
Largeur de face 50 mm

Detail of mullion VISS Linea
Width 50 mm

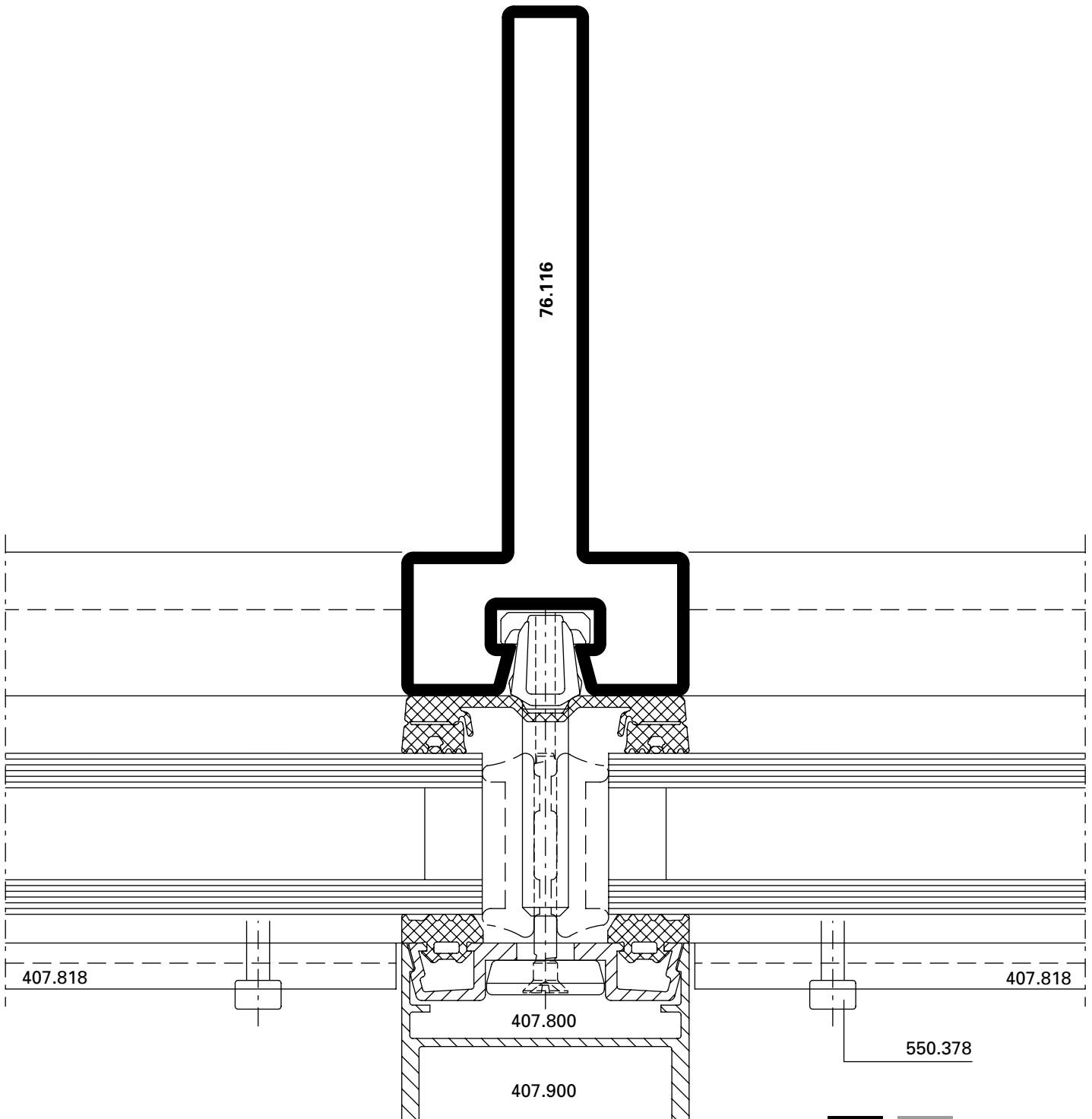

DXF

DWG

D-510-C-016

U_f-Werte siehe ab Seite 22-82

Valeurs U_f voir à partir de page 22-82

U_f values see from page 22-82

Schnittpunkte im Massstab 1:1
Coupe de détails à l'échelle 1:1
Section details on scale 1:1

VISS Fassade
VISS façade
VISS façade

Pfosten-Detail VISS Linea
Lasergeschweisst
Ansichtsbreite 50 mm

Détail du montant VISS Linea
Soudage au laser
Largeur de face 50 mm

Detail of mullion VISS Linea
Laser welding
Width 50 mm

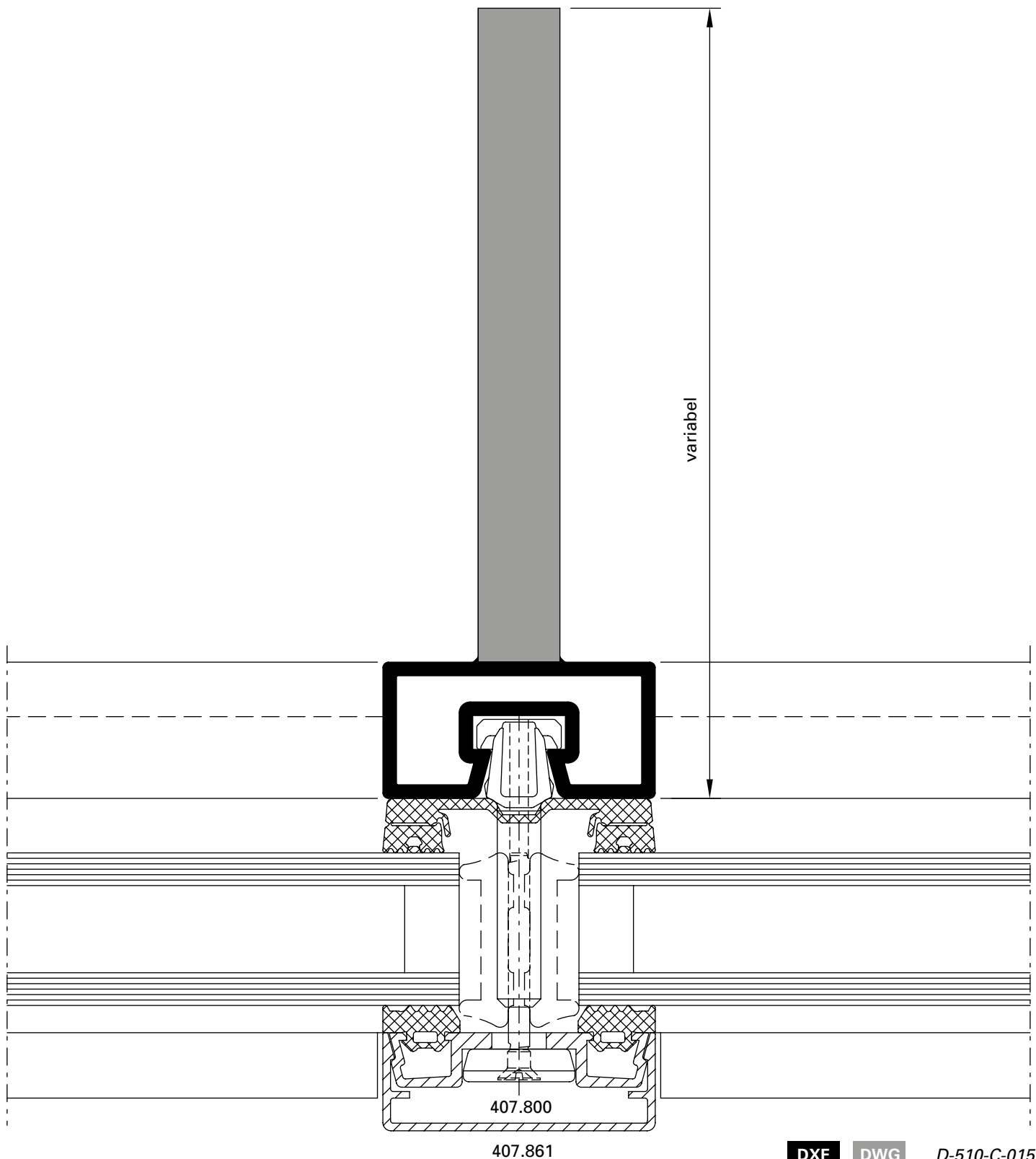

DXF

DWG

D-510-C-015

Schnittpunkte im Massstab 1:2
Coupe de détails à l'échelle 1:2
Section details on scale 1:2

VISS Fassade
VISS façade
VISS façade

Pfosten-Detail
Flaches Deckprofil
Ansichtsbreite 50 mm

Détail du montant
Profilé de recouvrement plat
Largeur de face 50 mm

Detail of mullion
Flat cover cap
Width 50 mm

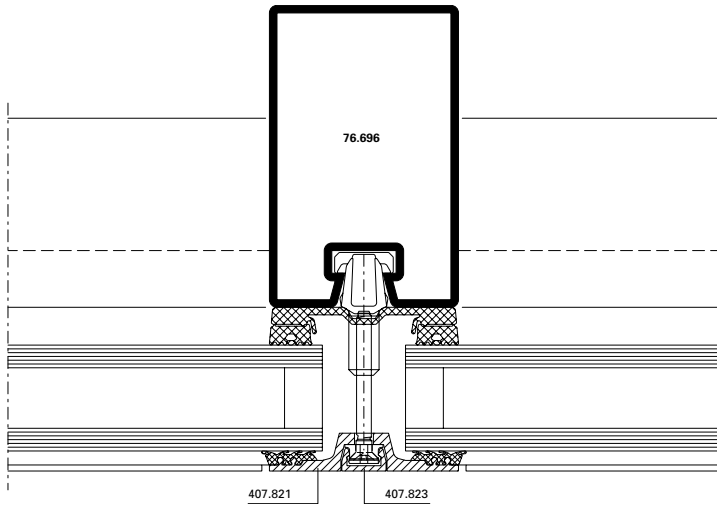

DXF

DWG

D-510-C-017

Riegel-Detail
Flaches Deckprofil
Ansichtsbreite 50 mm

Détail de la traverse
Profilé de recouvrement plat
Largeur de face 50 mm

Detail of transom
Flat cover cap
Width 50 mm

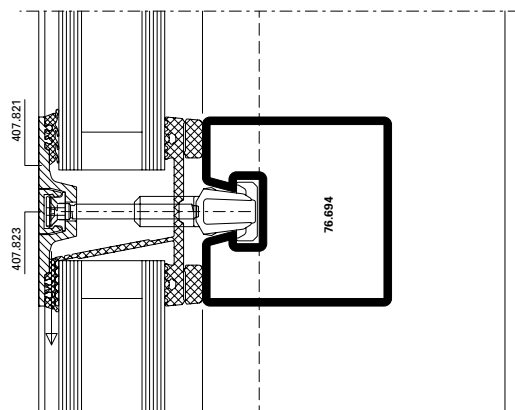

D-510-C-018

DWG

DXF

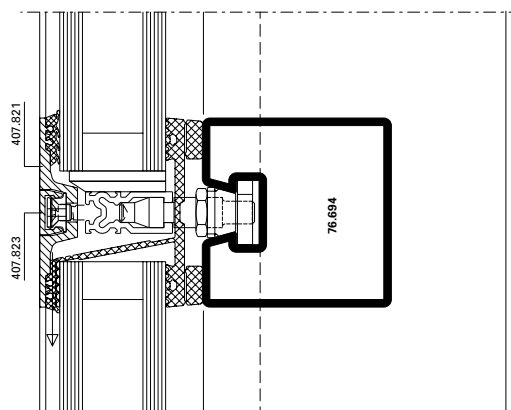

D-510-C-019

DWG

DXF

Schnittpunkte im Massstab 1:2
 Coupe de détails à l'échelle 1:2
 Section details on scale 1:2

VISS Fassade
 VISS façade
 VISS façade

Pfosten-Detail VISS Linea
 Ansichtsbreite 50 mm

Détail du montant VISS Linea
 Largeur de face 50 mm

Detail of mullion VISS Linea
 Width 50 mm

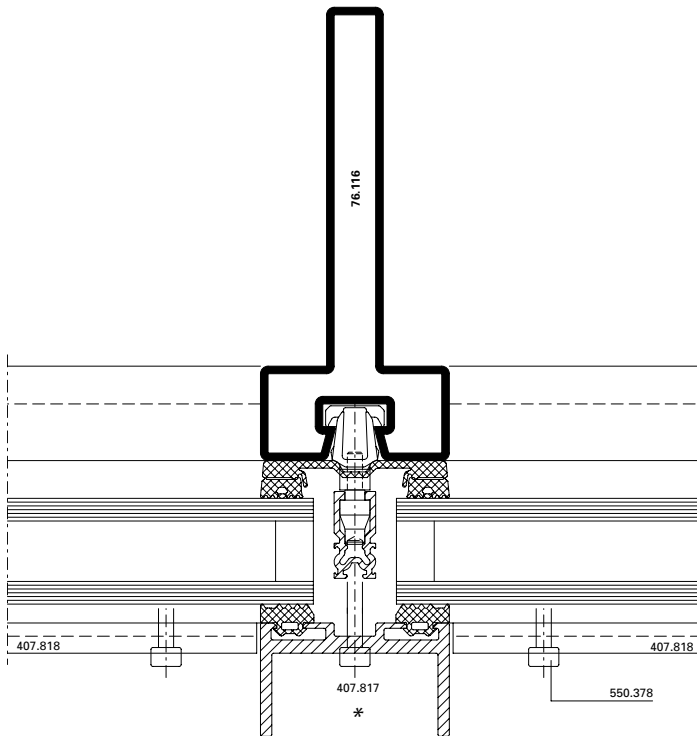

DXF DWG D-510-C-007

Riegel-Detail VISS Linea
 Ansichtsbreite 50 mm

Détail de la traverse VISS Linea
 Largeur de face 50 mm

Detail of transom VISS Linea
 Width 50 mm

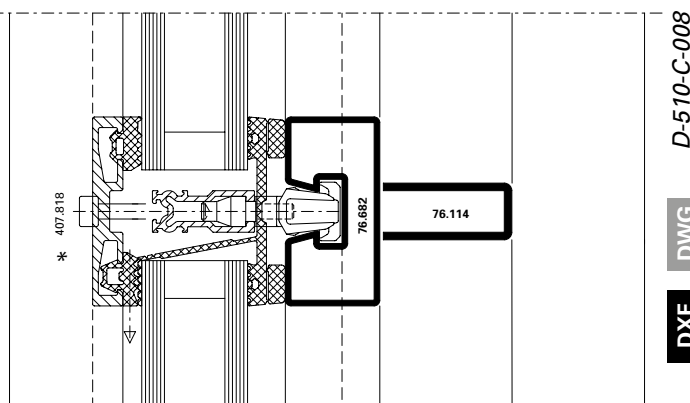

D-510-C-008

DXF DWG

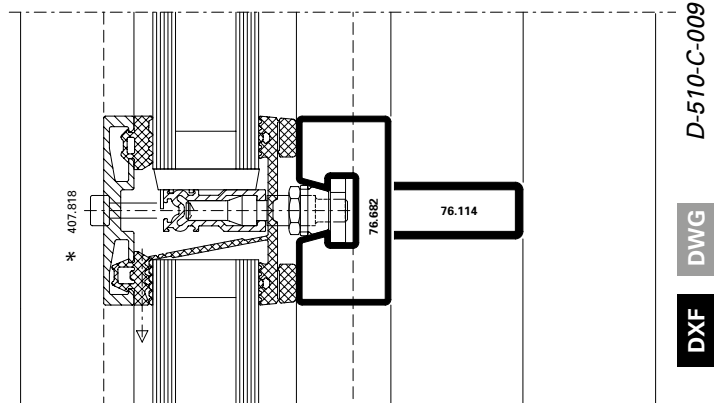

D-510-C-009

DXF DWG

* Sonderkonstruktion
 (nach Produktnorm EN 13830
 nicht geprüft)

* Construction spéciale
 (non contrôlé selon la norme
 produit EN 13830)

* Special construction
 (Not tested in accordance with the
 EN 13830 product standard)

Schnittpunkte im Masstab 1:2
Coupe de détails à l'échelle 1:2
Section details on scale 1:2

VISS Fassade
VISS façade
VISS façade

Pfosten-Detail
Einfachverglasung
Ansichtsbreite 50 mm

Détail du montant
Vitrage simple
Largeur de face 50 mm

Detail of mullion
Single glazing
Width 50 mm

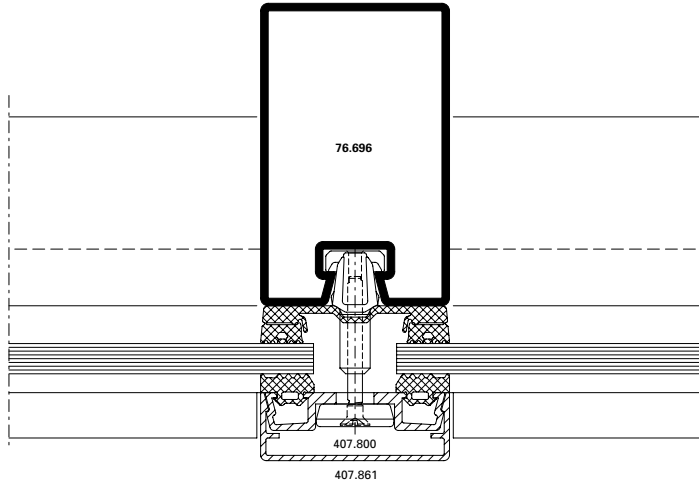

DXF **DWG** D-510-C-012

Riegel-Detail
Einfachverglasung
Ansichtsbreite 50 mm

Détail de la traverse
Vitrage simple
Largeur de face 50 mm

Detail of transom
Single glazing
Width 50 mm

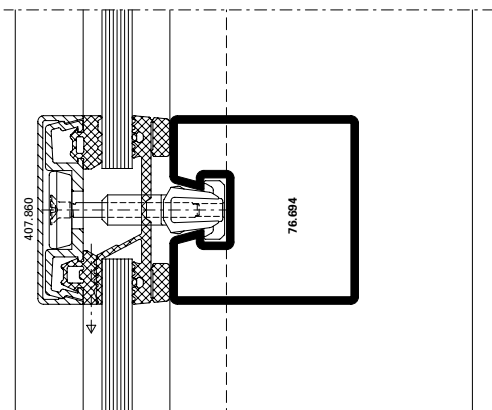

D-510-C-013

DWG

DXF

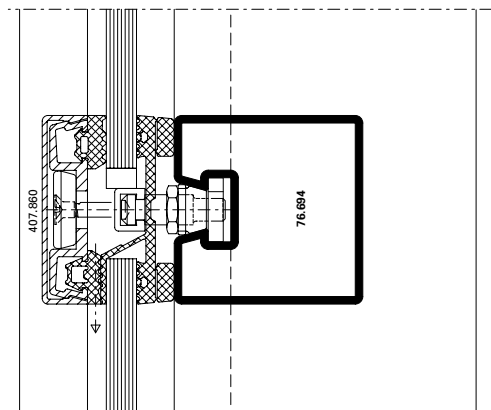

D-510-C-014

DWG

DXF

Schnittpunkte im Massstab 1:1
Coupe de détails à l'échelle 1:1
Section details on scale 1:1

VISS Fassade
VISS façade
VISS façade

VISS HI
Pfosten-Detail
Ansichtsbreite 60 mm

VISS HI
Détail du montant
Largeur de face 60 mm

VISS HI
Detail of mullion
Width 60 mm

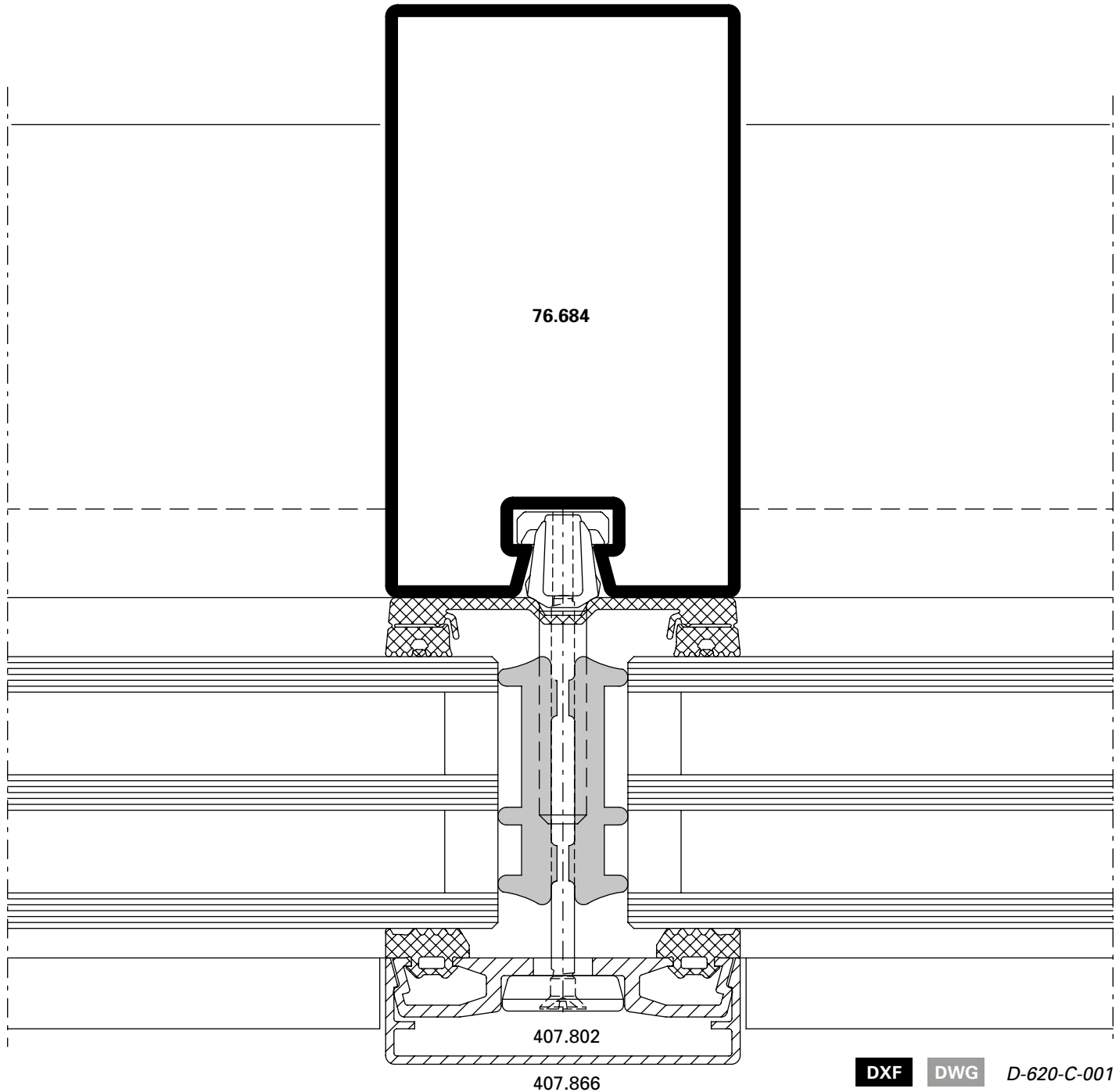

DXF DWG D-620-C-001

U_f-Werte siehe ab Seite 22-82

Valeurs U_f voir à partir de page 22-82

U_f values see from page 22-82

Schnittpunkte im Massstab 1:1
Coupe de détails à l'échelle 1:1
Section details on scale 1:1

VISS Fassade
VISS façade
VISS façade

VISS HI
Riegel-Detail
Ansichtsbreite 60 mm

VISS HI
Détail de la traverse
Largeur de face 60 mm

VISS HI
Detail of transom
Width 60 mm

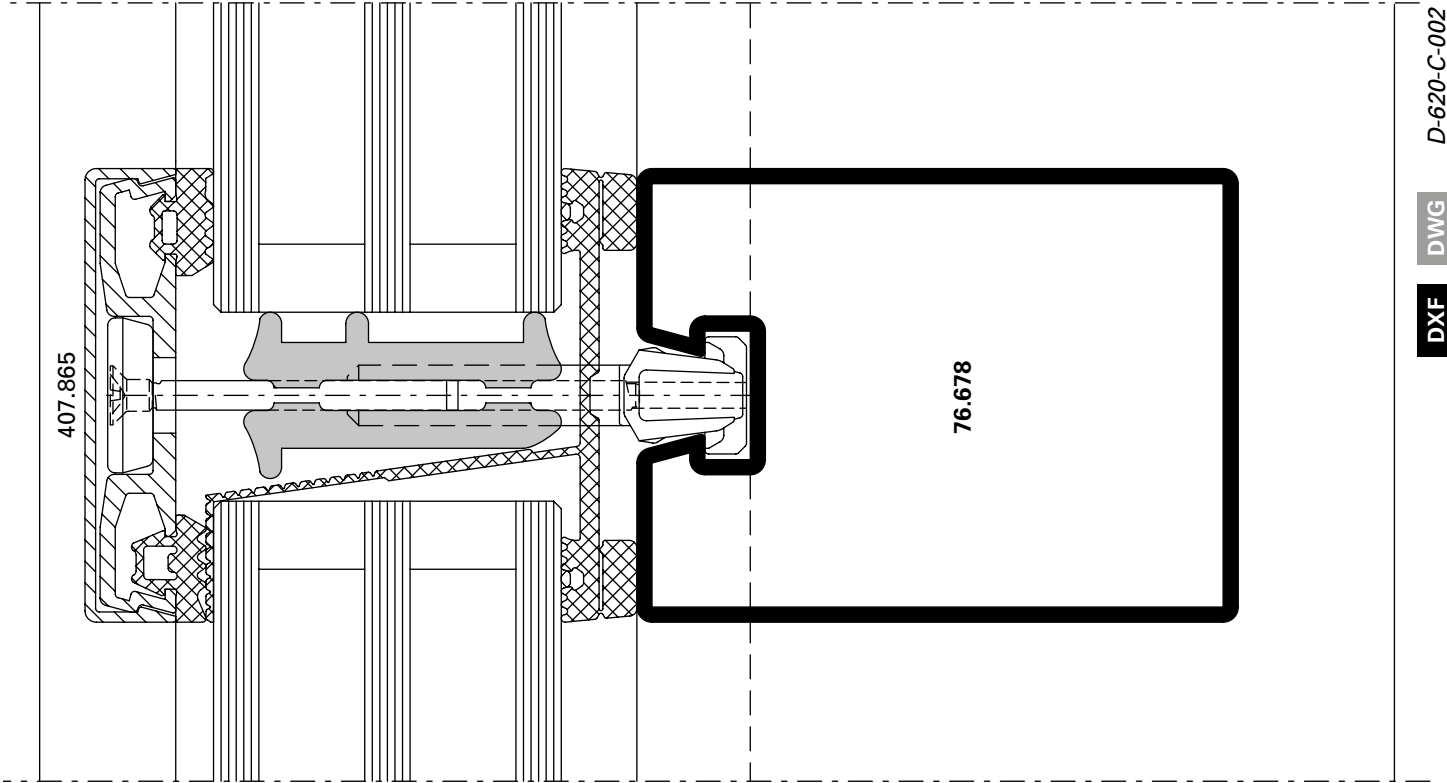

DWG D-620-C-002

DWG

DXF

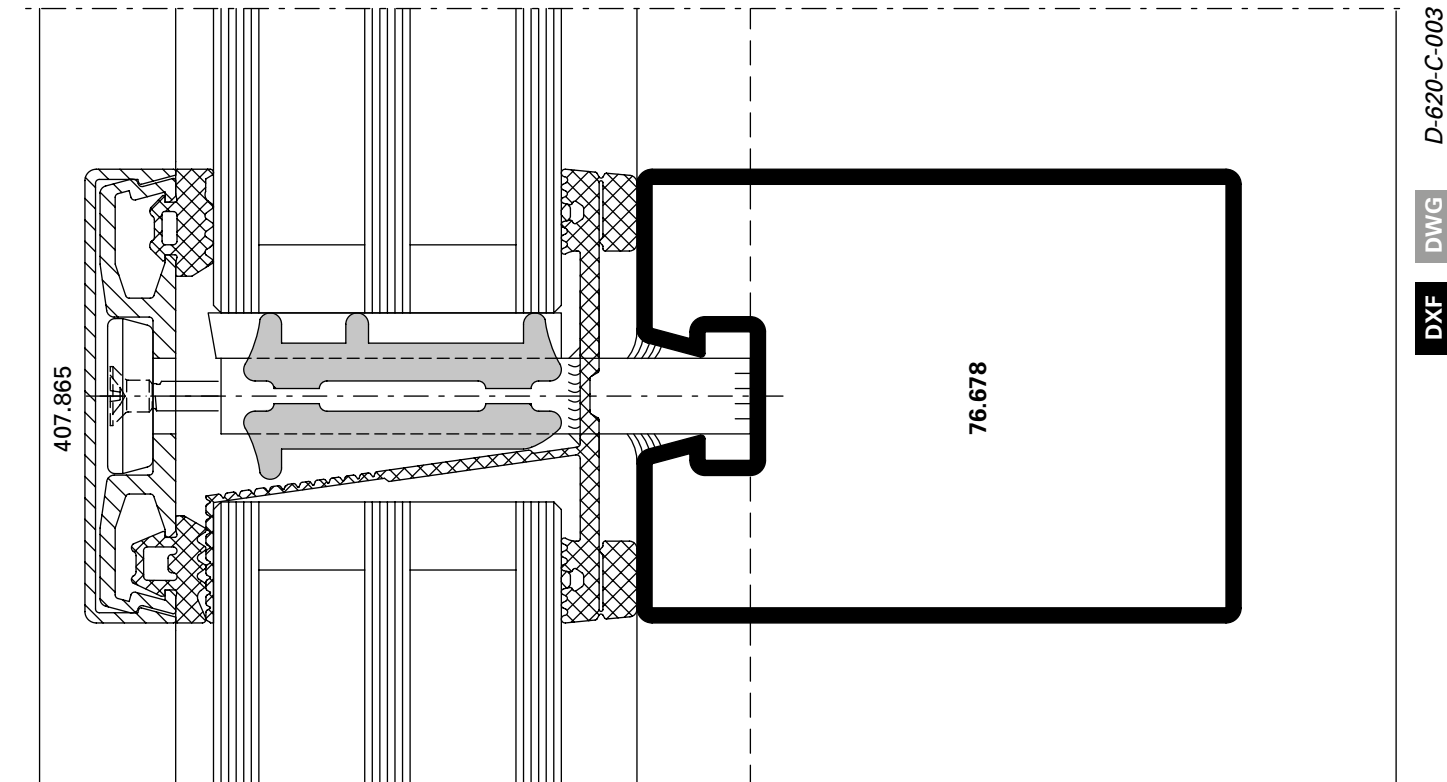

DWG D-620-C-003

DWG

DXF

Schnittpunkte im Massstab 1:1
Coupe de détails à l'échelle 1:1
Section details on scale 1:1

VISS Fassade
VISS façade
VISS façade

Pfosten-Detail
Ansichtsbreite 60 mm

Détail du montant
Largeur de face 60 mm

Detail of mullion
Width 60 mm

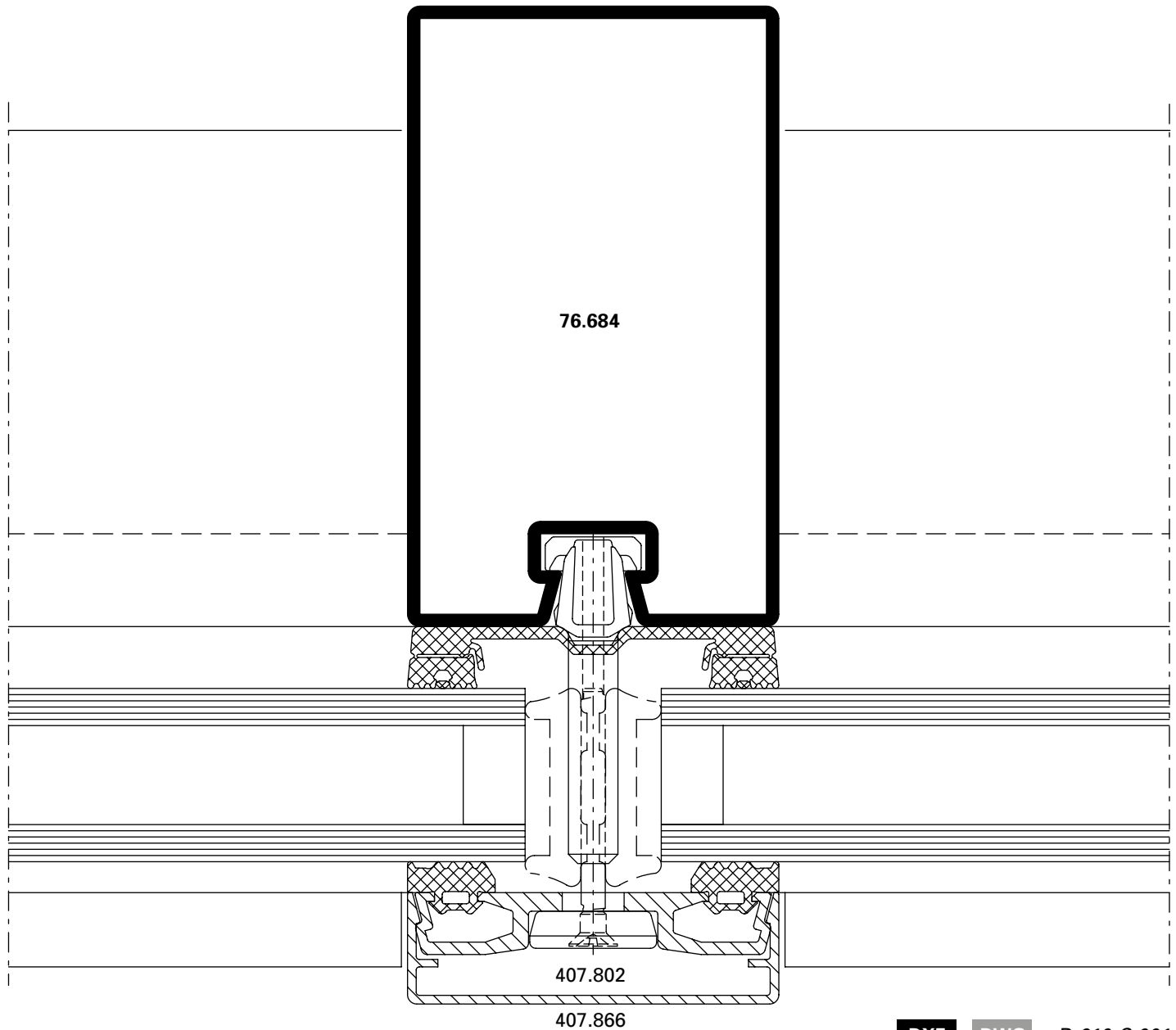

DXF **DWG** D-610-C-001

U_f-Werte siehe ab Seite 22-82

Valeurs U_f voir à partir de page 22-82

U_f values see from page 22-82

Riegel-Detail
Ansichtsbreite 60 mm

Détail de la traverse
Largeur de face 60 mm

Detail of transom
Width 60 mm

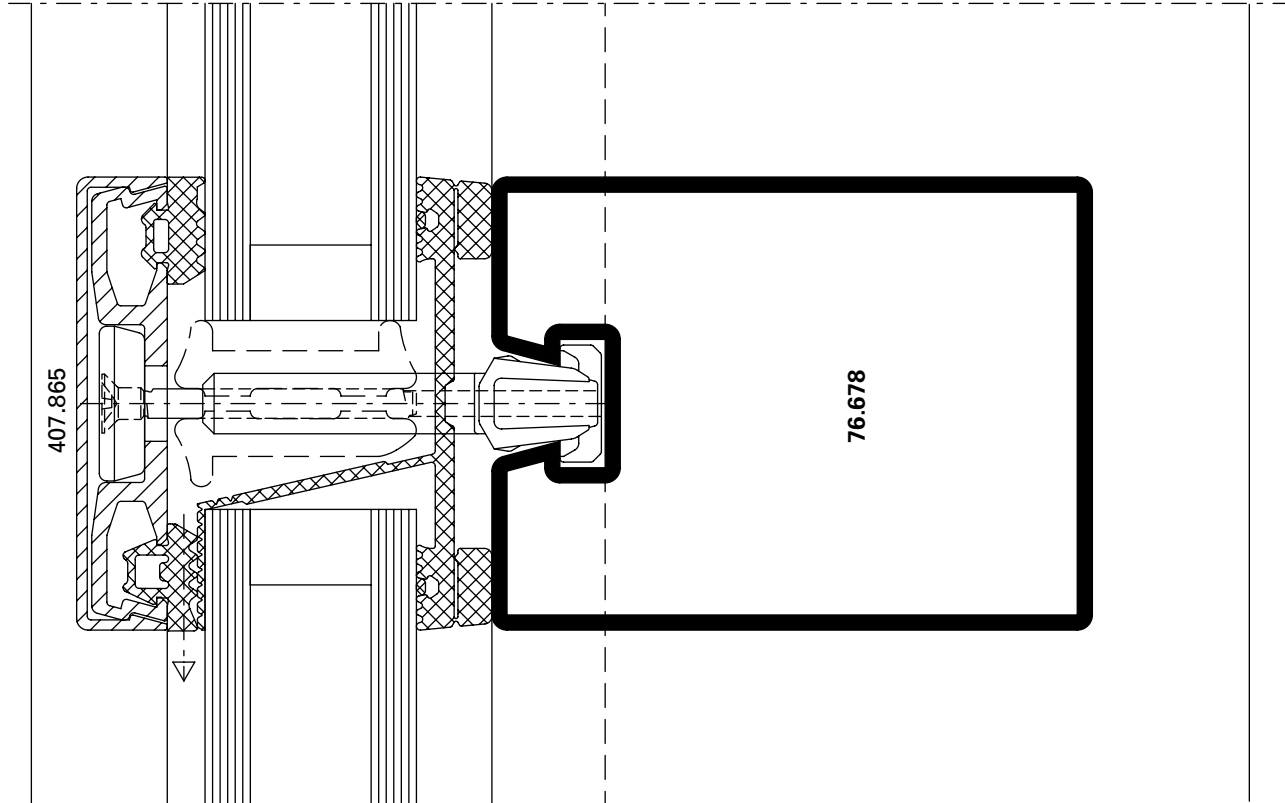

D-610-C-002

DWG

DXF

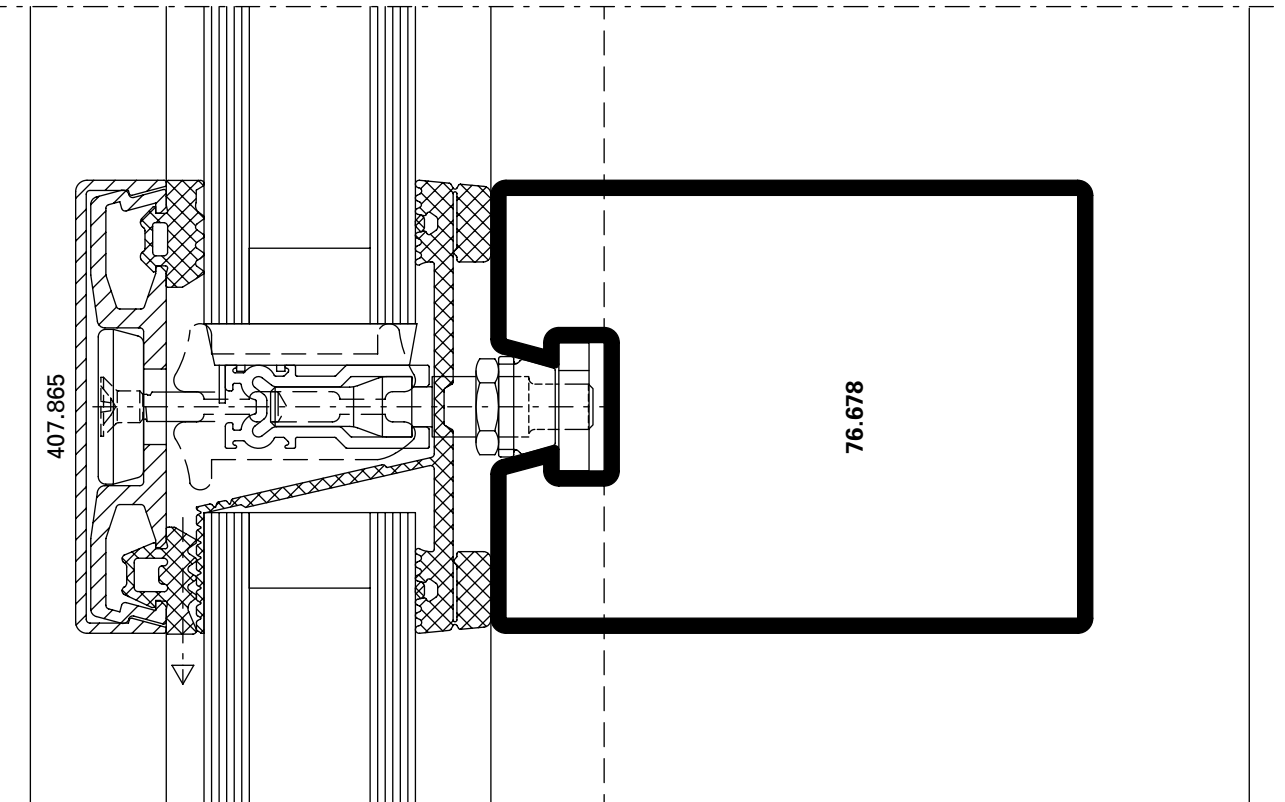

D-610-C-003

DWG

DXF

Schnittpunkte im Massstab 1:1
Coupe de détails à l'échelle 1:1
Section details on scale 1:1

VISS Fassade
VISS façade
VISS façade

Pfosten-Detail VISS Delta
Ansichtsbreite 60 mm

Détail du montant VISS Delta
Largeur de face 60 mm

Detail of mullion VISS Delta
Width 60 mm

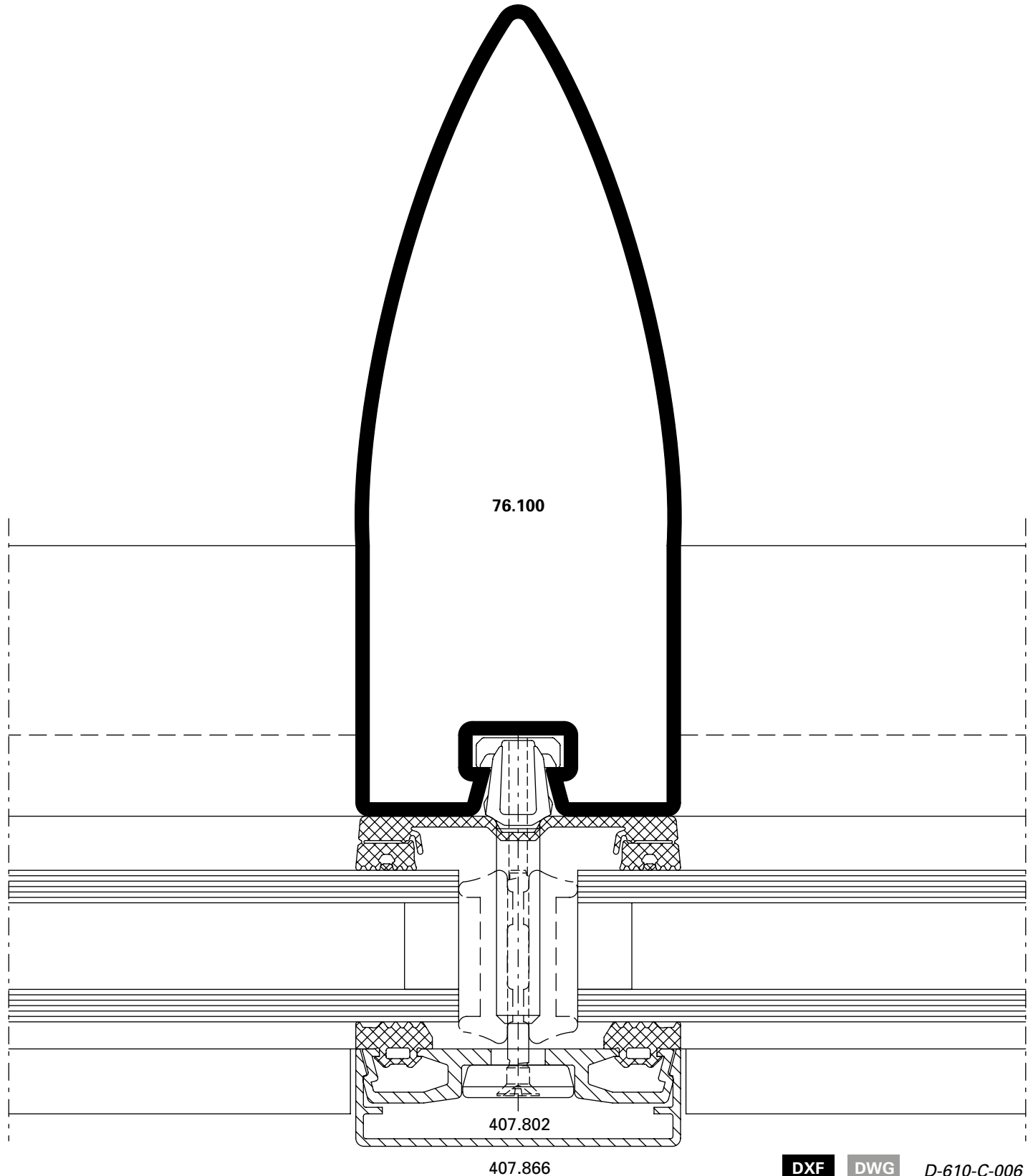

Pfosten-Detail VISS Delta*
Ansichtsbreite 60 mm

Détail du montant VISS Delta*
Largeur de face 60 mm

Detail of mullion VISS Delta*
Width 60 mm

* Sonderkonstruktion
(nach Produktnorm EN 13830
nicht geprüft)

* Construction spéciale
(non contrôlé selon la norme
produit EN 13830)

* Special construction
(Not tested in accordance with the
EN 13830 product standard)

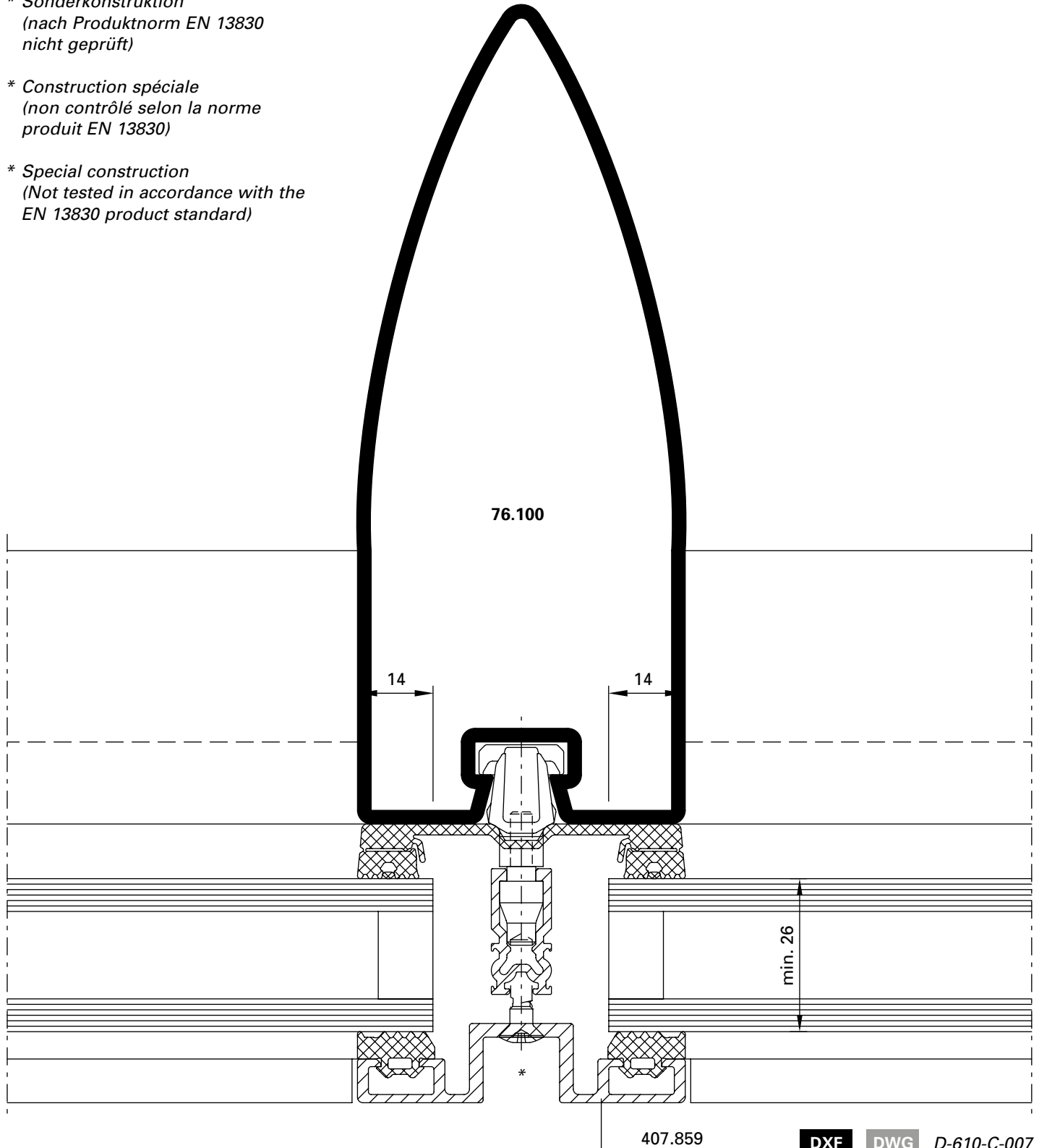

DXF

DWG

D-610-C-007

Schnittpunkte im Massstab 1:1
 Coupe de détails à l'échelle 1:1
 Section details on scale 1:1

VISS Fassade
 VISS façade
 VISS façade

Pfosten-Detail
 Segmentverglasung 60 mm

Détail du montant
 Vitrage segmenté 60 mm

Detail of mullion
 Segmental glazing, width 60 mm

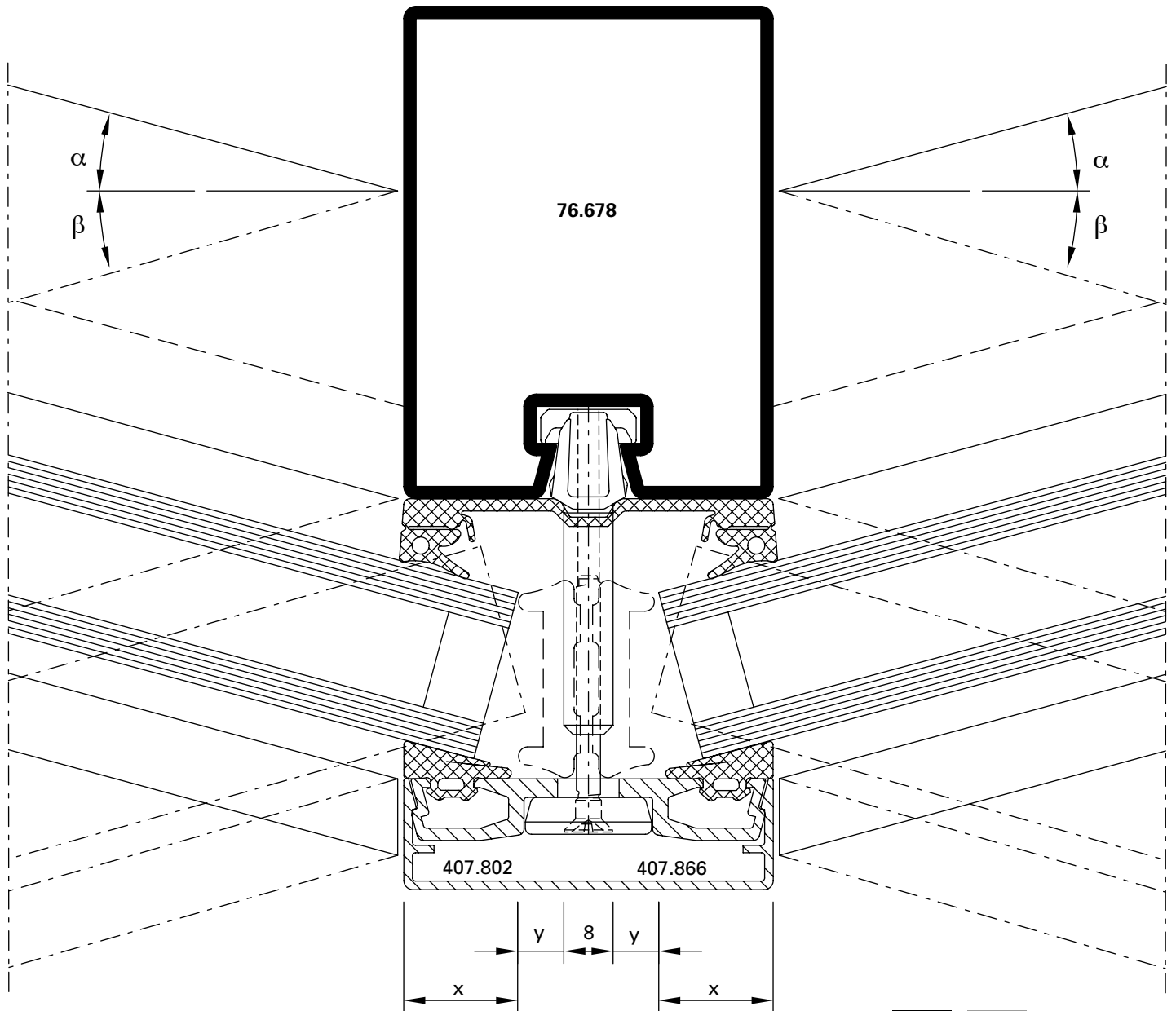

DXF DWG D-610-C-004

α	β	Füllelement- dicke	X (max) mm	Y (min) mm
0 – 5°		20 – 70 mm	21	5
	5 – 10°	20 – 50 mm	21	5
	10 – 15°	20 – 35 mm	21	5

α	β	Epaisseur du remplissage	X (max) mm	Y (min) mm
0 – 5°		20 – 70 mm	21	5
	5 – 10°	20 – 50 mm	21	5
	10 – 15°	20 – 35 mm	21	5

α	β	Thickness of glass/panel	X (max) mm	Y (min) mm
0 – 5°		20 – 70 mm	21	5
	5 – 10°	20 – 50 mm	21	5
	10 – 15°	20 – 35 mm	21	5

Schnittpunkte im Massstab 1:2
Coupe de détails à l'échelle 1:2
Section details on scale 1:2

VISS Fassade
VISS façade
VISS façade

Pfosten-Detail
Flaches Deckprofil
Ansichtsbreite 60 mm

Détail du montant
Profilé de recouvrement plat
Largeur de face 60 mm

Detail of mullion
Flat cover cap
Width 60 mm

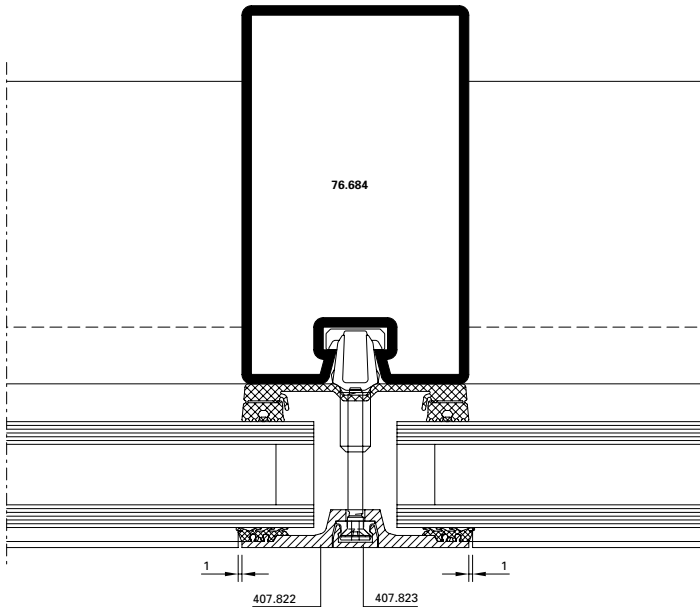

DXF **DWG** D-610-C-011

Riegel-Detail
Flaches Deckprofil
Ansichtsbreite 60 mm

Détail de la traverse
Profilé de recouvrement plat
Largeur de face 60 mm

Detail of transom
Flat cover cap
Width 60 mm

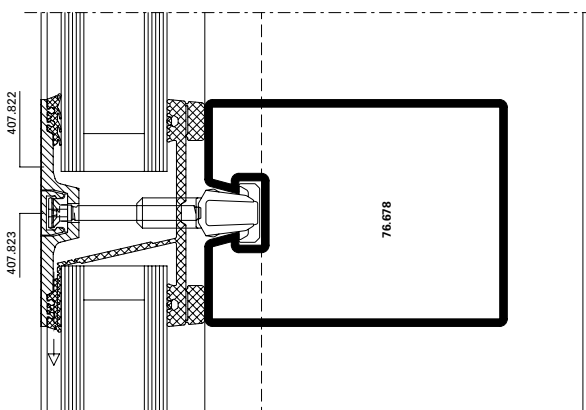

DXF **DWG** D-610-C-012

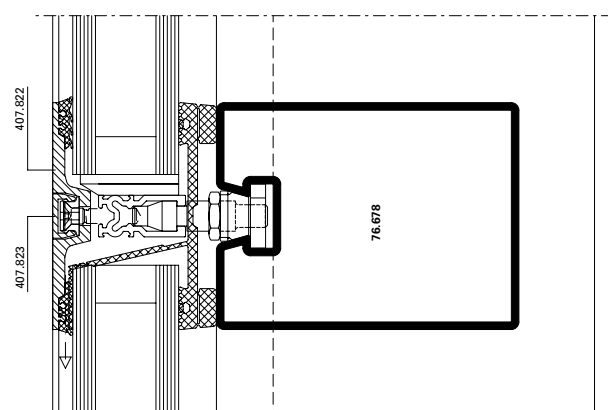

DXF **DWG** D-610-C-013

Schnittpunkte im Massstab 1:2
Coupe de détails à l'échelle 1:2
Section details on scale 1:2

VISS Fassade
VISS façade
VISS façade

Pfosten-Detail
Einfachverglasung
Ansichtsbreite 60 mm

Détail du montant
Vitrage simple
Largeur de face 60 mm

Detail of mullion
Single glazing
Width 60 mm

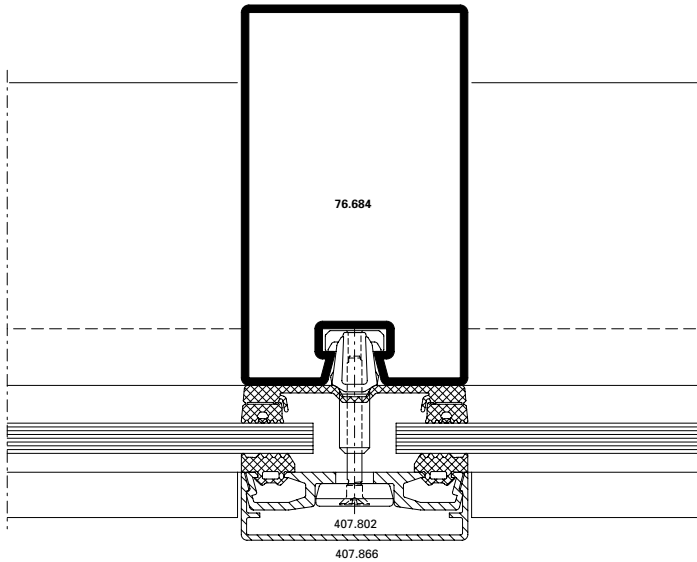

DXF **DWG** D-610-C-008

Riegel-Detail
Einfachverglasung
Ansichtsbreite 60 mm

Détail de la traverse
Vitrage simple
Largeur de face 60 mm

Detail of transom
Single glazing
Width 60 mm

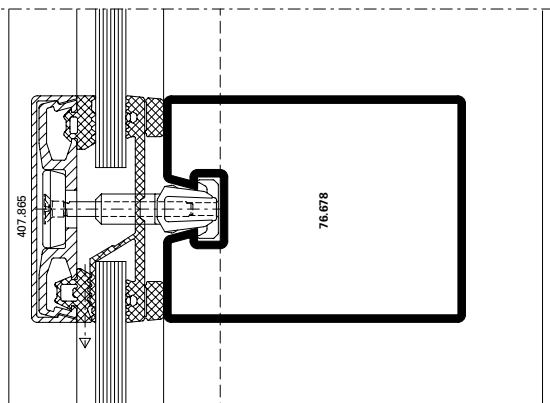

D-610-C-009

DXF **DWG**

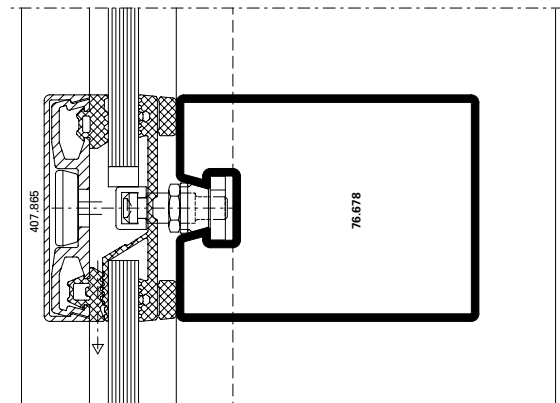

D-610-C-010

DXF **DWG**

Einsatzelement
 Janisol HI Türe

Élément de remplissage
 Porte Janisol HI

Infill element
 Janisol HI door

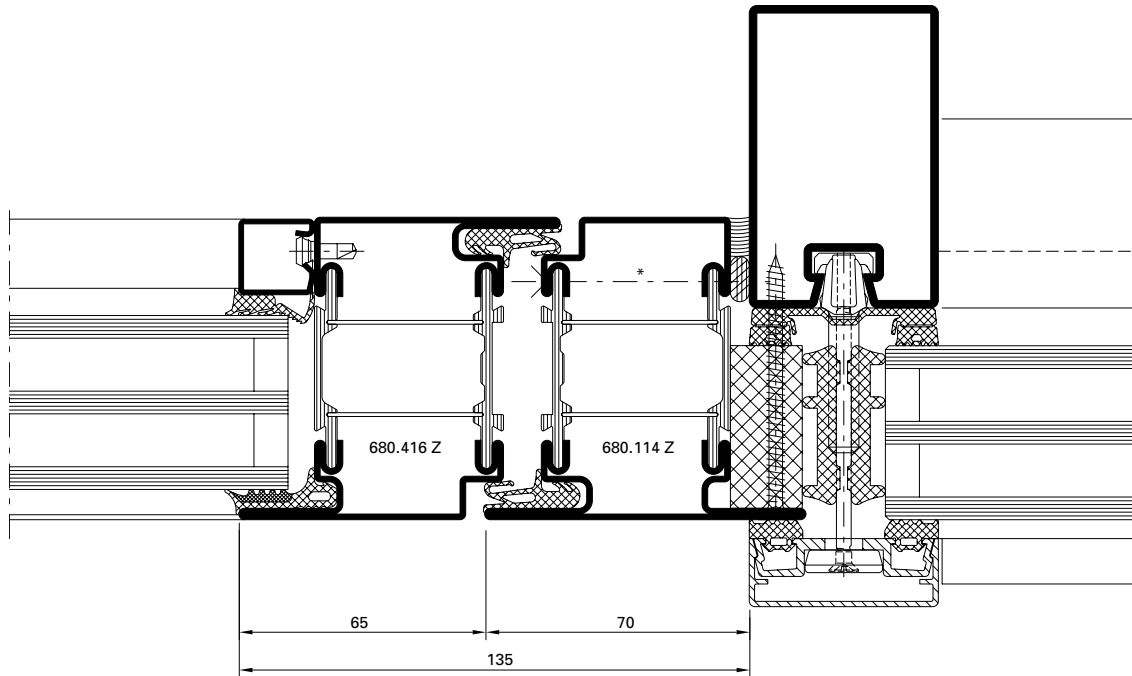

DXF DWG

D-160-A-012

Einsatzelement
 Janisol HI Fenster

Élément de remplissage
 Fenêtre Janisol HI

Infill element
 Janisol HI window

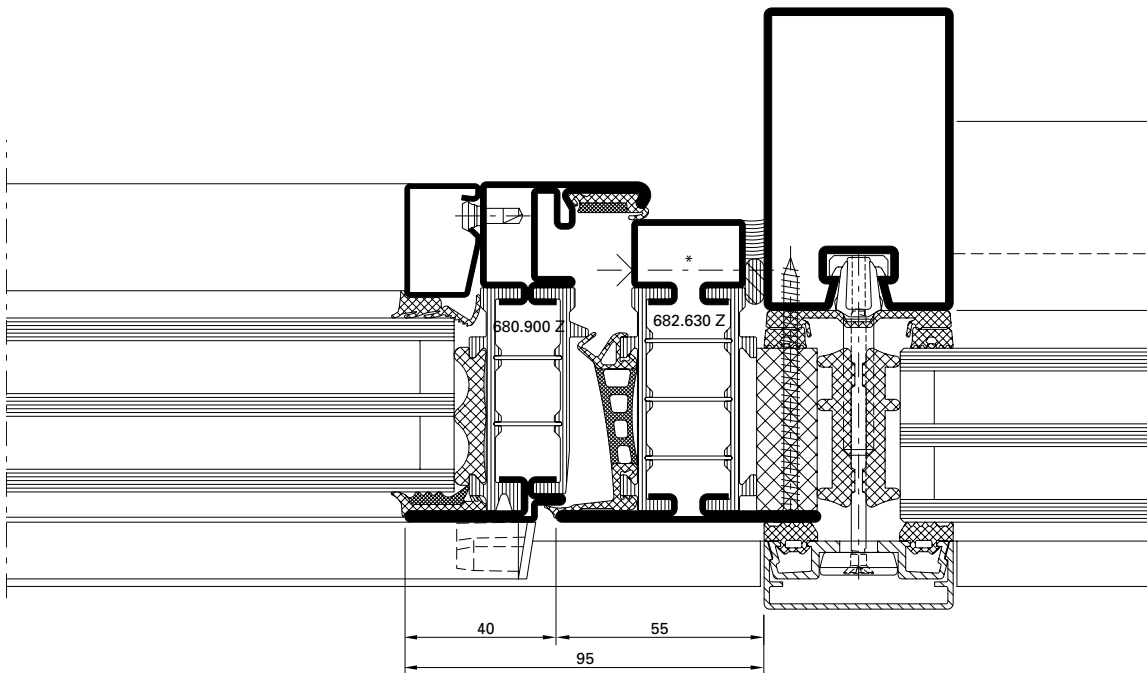

DXF DWG

D-161-A-018

* Bei grossen, schweren und/oder stark frequentierten Türanlagen ist eine zusätzliche Verschraubung im Bandbereich erforderlich.

* Pour les portes lourdes de grandes dimensions et/ou fortement fréquentées, un vissage supplémentaire au niveau des paumelles est nécessaire.

* for large heavy and/or frequently used door systems, additional screw connections are required in the hinge area.

Einsatzelement
 Janisol Türe

Élément de remplissage
 Porte Janisol

Infill element
 Janisol door

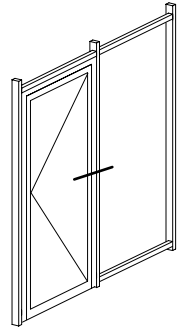
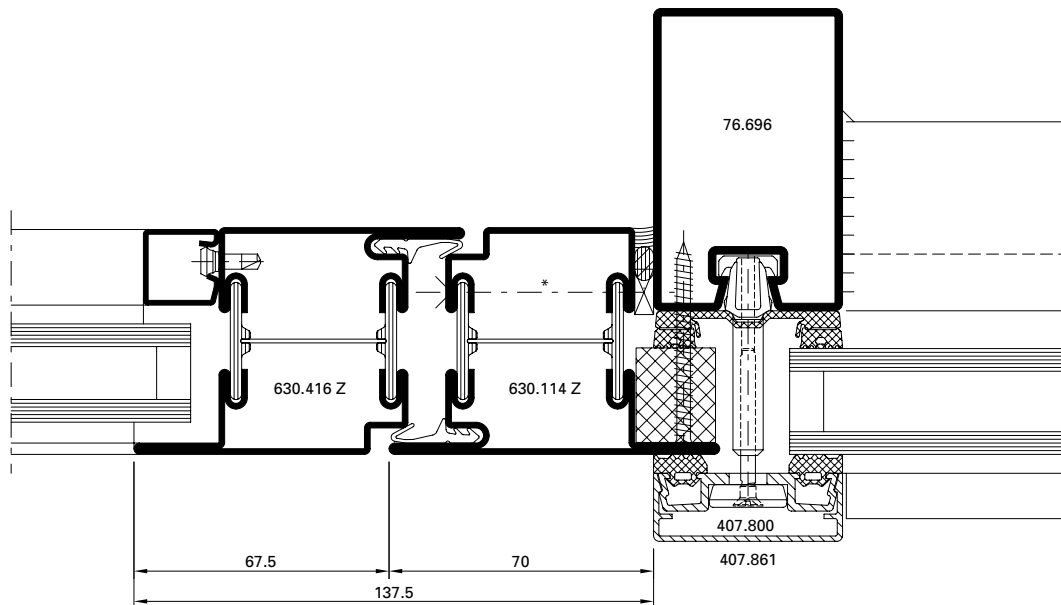

DXF DWG

D-510-K-002

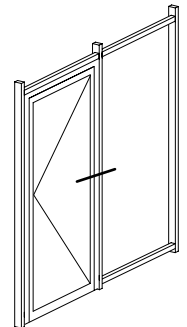
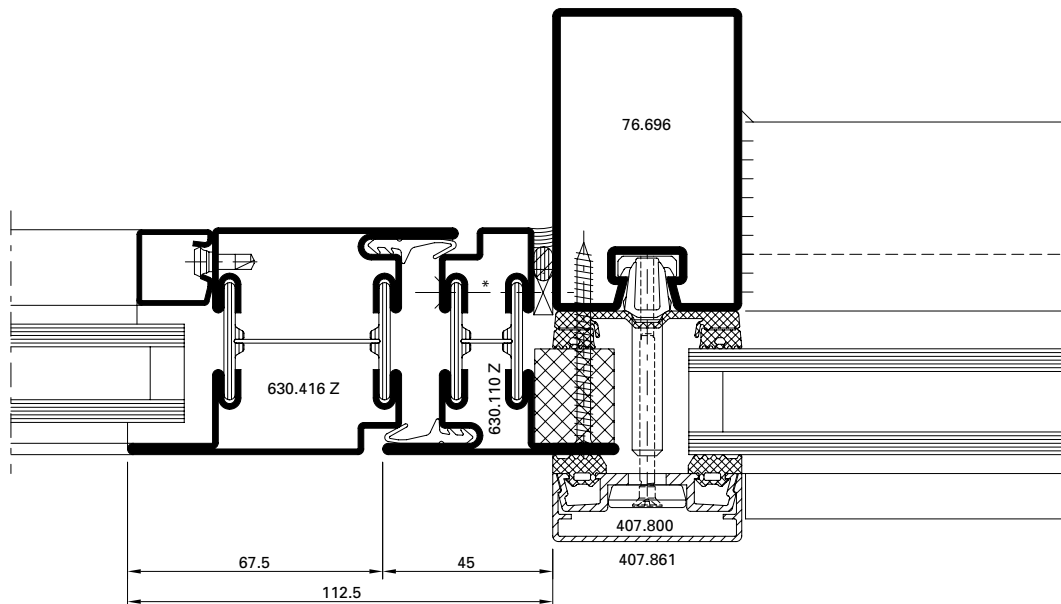

DXF DWG

D-510-K-007

* Bei grossen, schweren und/oder stark frequentierten Türanlagen ist eine zusätzliche Verschraubung im Bandbereich erforderlich.

* Pour les portes lourdes de grandes dimensions et/ou fortement fréquentées, un vissage supplémentaire au niveau des paumelles est nécessaire.

* for large heavy and/or frequently used door systems, additional screw connections are required in the hinge area.

Einsatzelement
 Fenster Janisol Primo

Élément de remplissage
 Fenêtre Janisol Primo

Infill element
 Janisol Primo window

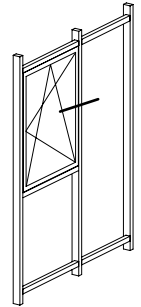
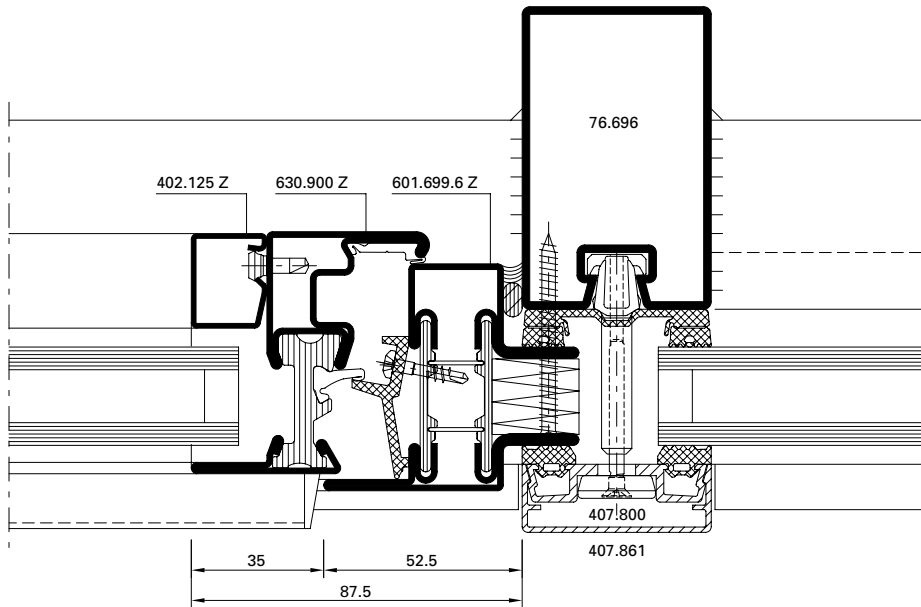

DXF DWG

D-510-K-001

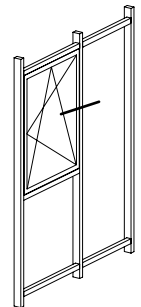
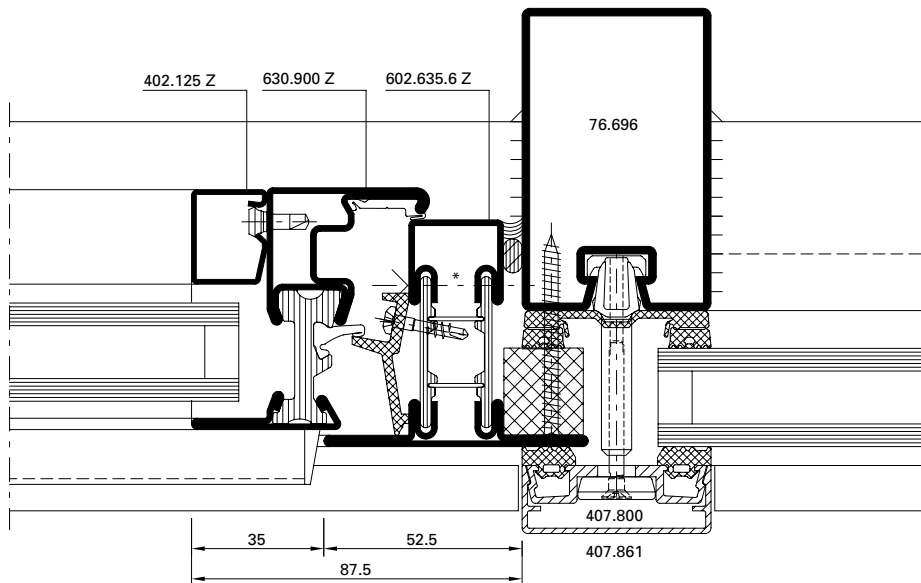

DXF DWG

D-510-K-006

* Bei grossen, schweren und/oder stark frequentierten Türanlagen ist eine zusätzliche Verschraubung im Bandbereich erforderlich.

* Pour les portes lourdes de grandes dimensions et/ou fortement fréquentées, un vissage supplémentaire au niveau des paumelles est nécessaire.

* for large heavy and/or frequently used door systems, additional screw connections are required in the hinge area.

Aussenecke 90°

Angle extérieur 90°

Outer corner 90°

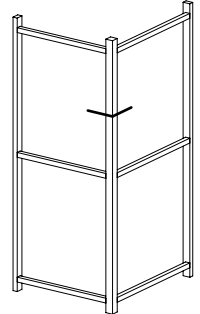
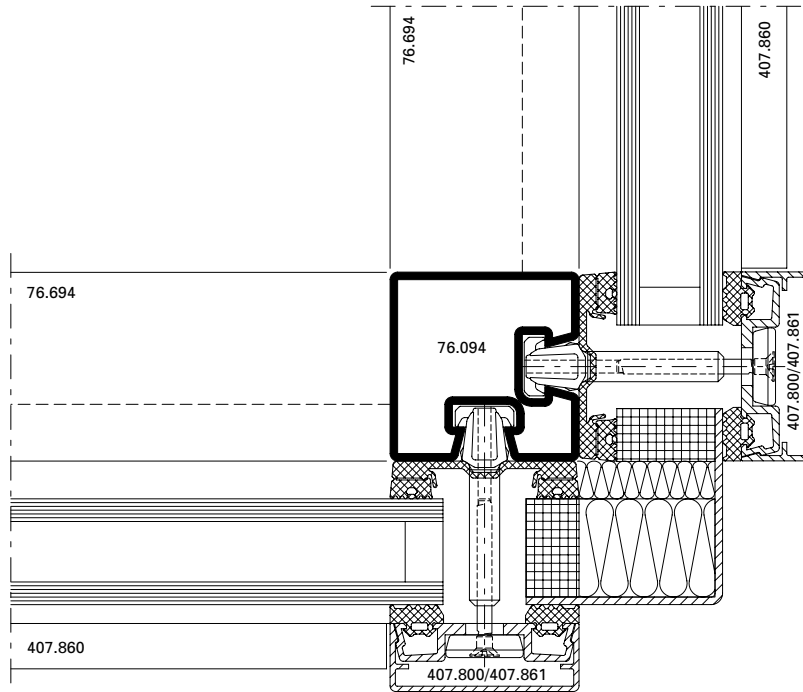

DXF DWG

D-510-K-011

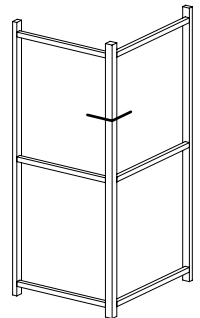
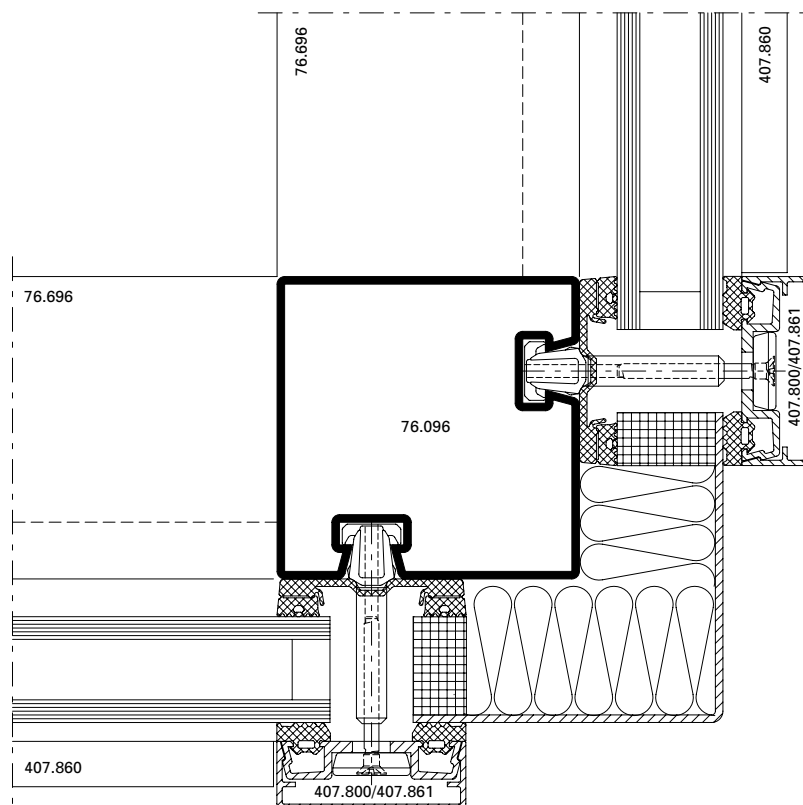

DXF DWG

D-510-K-012

Aussenecke 90°

Angle extérieur 90°

Outer corner 90°

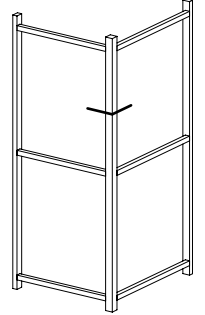
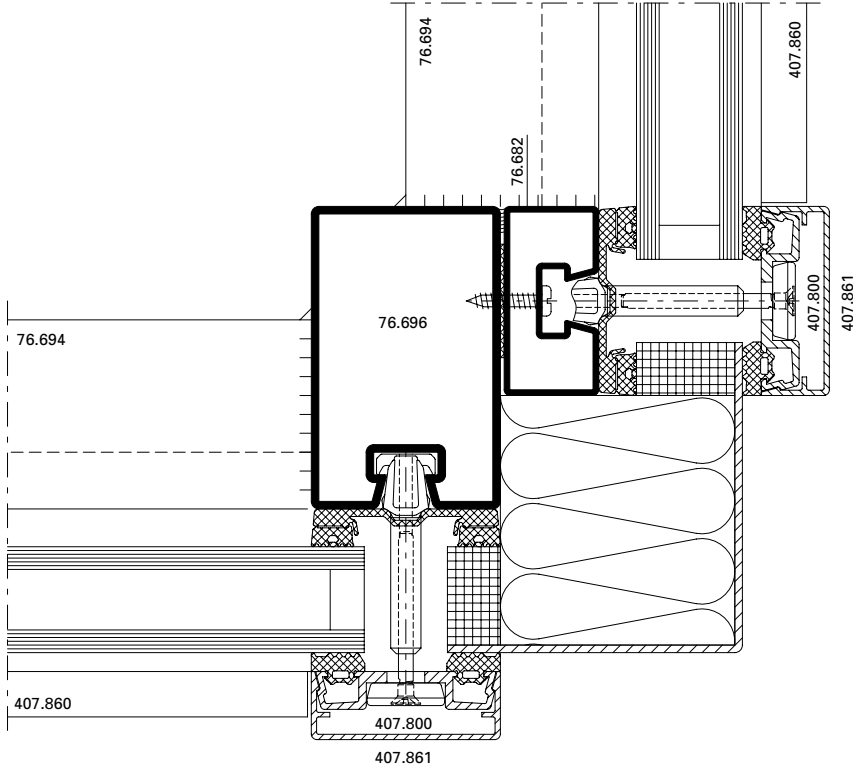

DXF DWG

D-510-K-005

Aussenecke 90°
(Kombination mit VISS Basic)

Angle extérieur 90°
(en combinaison avec VISS Basic)

Outer corner 90°
(in combination with VISS Basic)

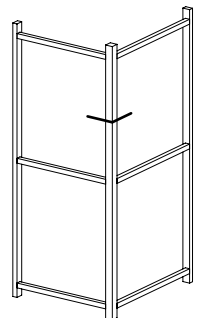
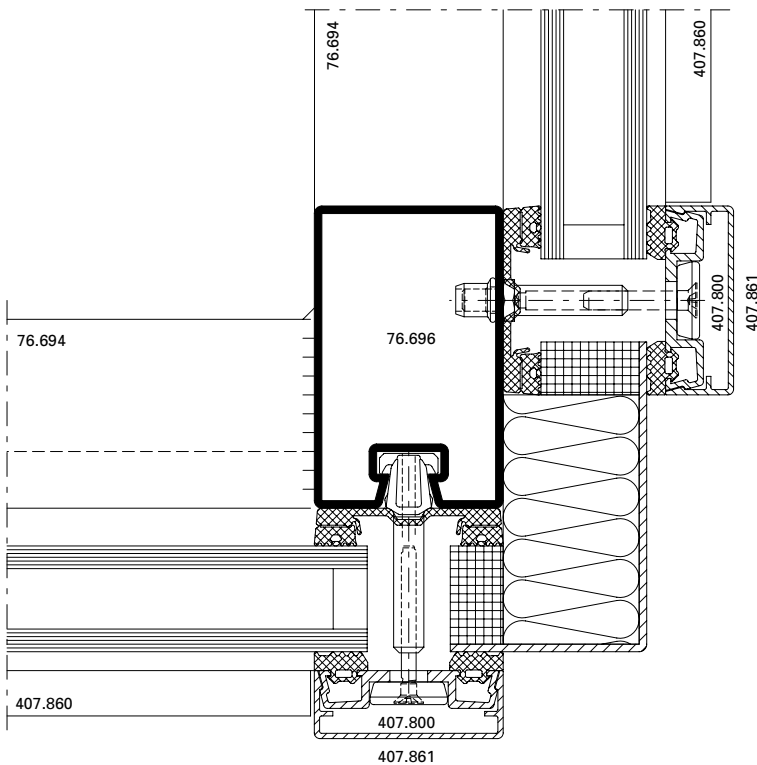

DXF DWG

D-510-K-010

Aussenecke 135°

Angle extérieur 135°

Outer corner 135°

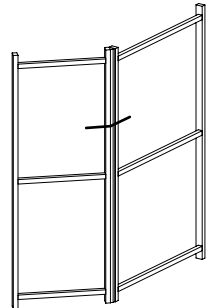
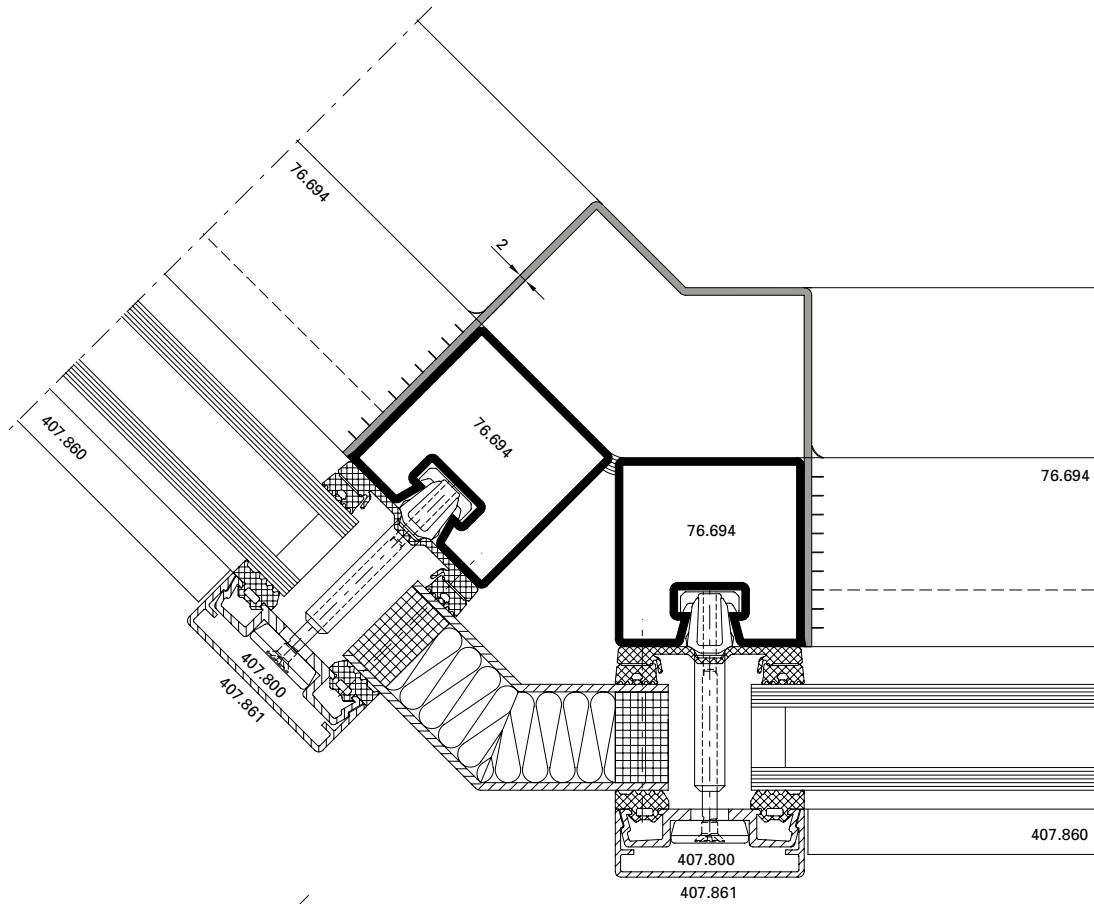

DXF DWG

D-510-K-003

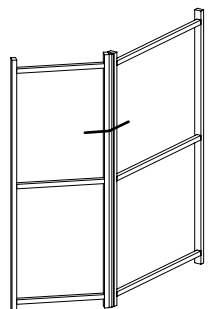
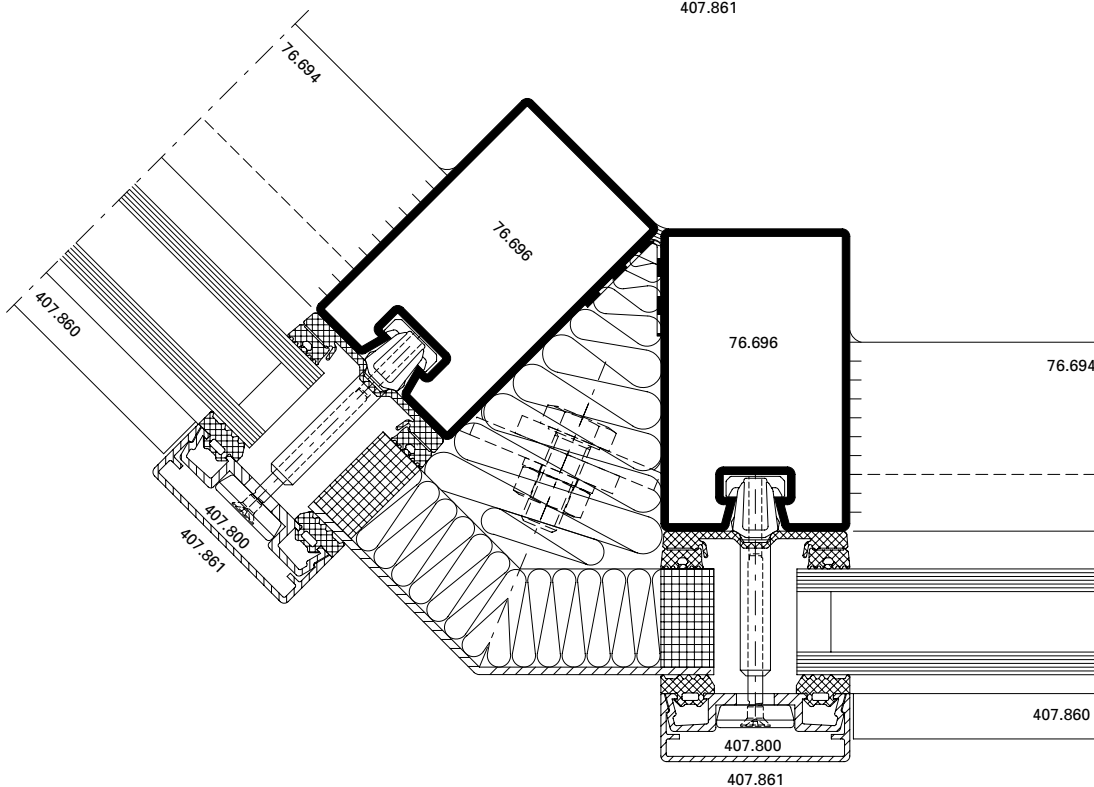

DXF DWG

D-510-K-004

Innenecke 135°

Angle intérieur 135°

Inner corner 135°

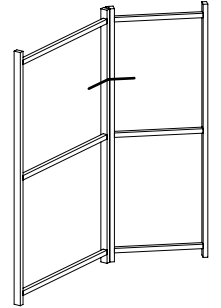
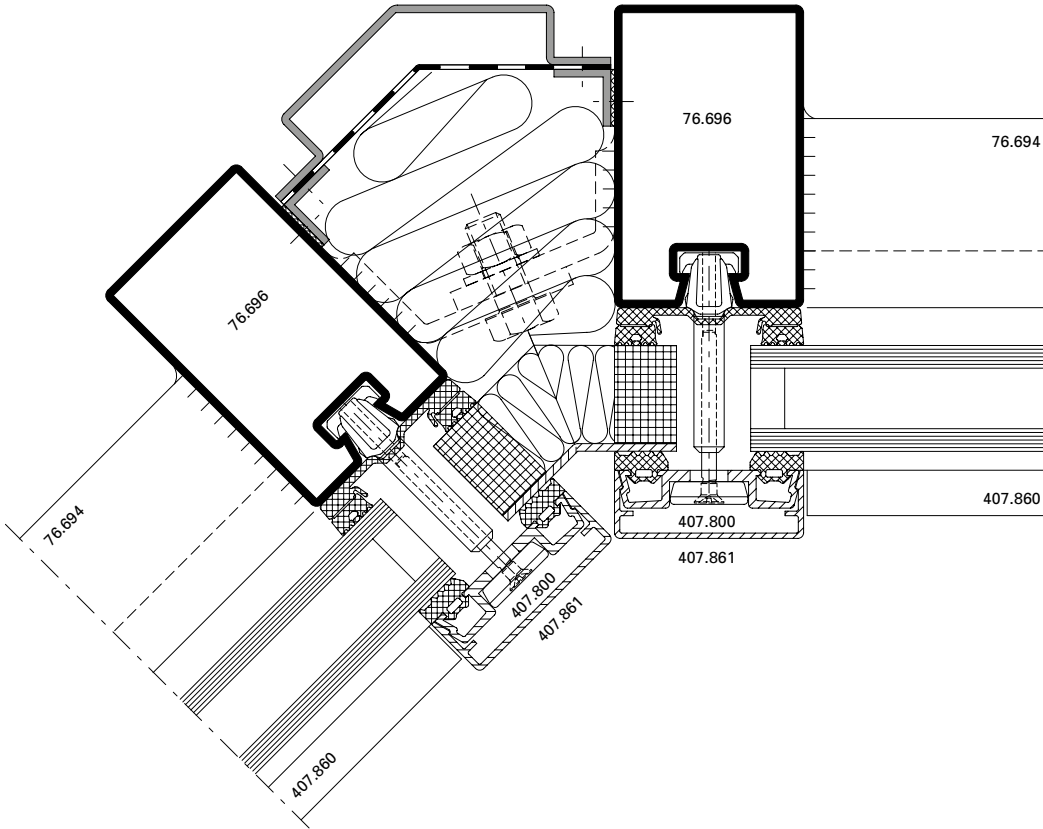

DXF DWG

D-510-K-009

Anschlüsse am Bau im Masstab 1:2
Raccords au mur à l'échelle 1:2
Attachment to structure on scale 1:2

VISS Fassade
VISS façade
VISS façade

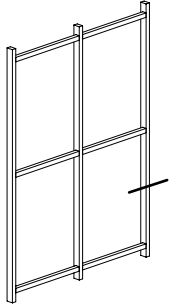
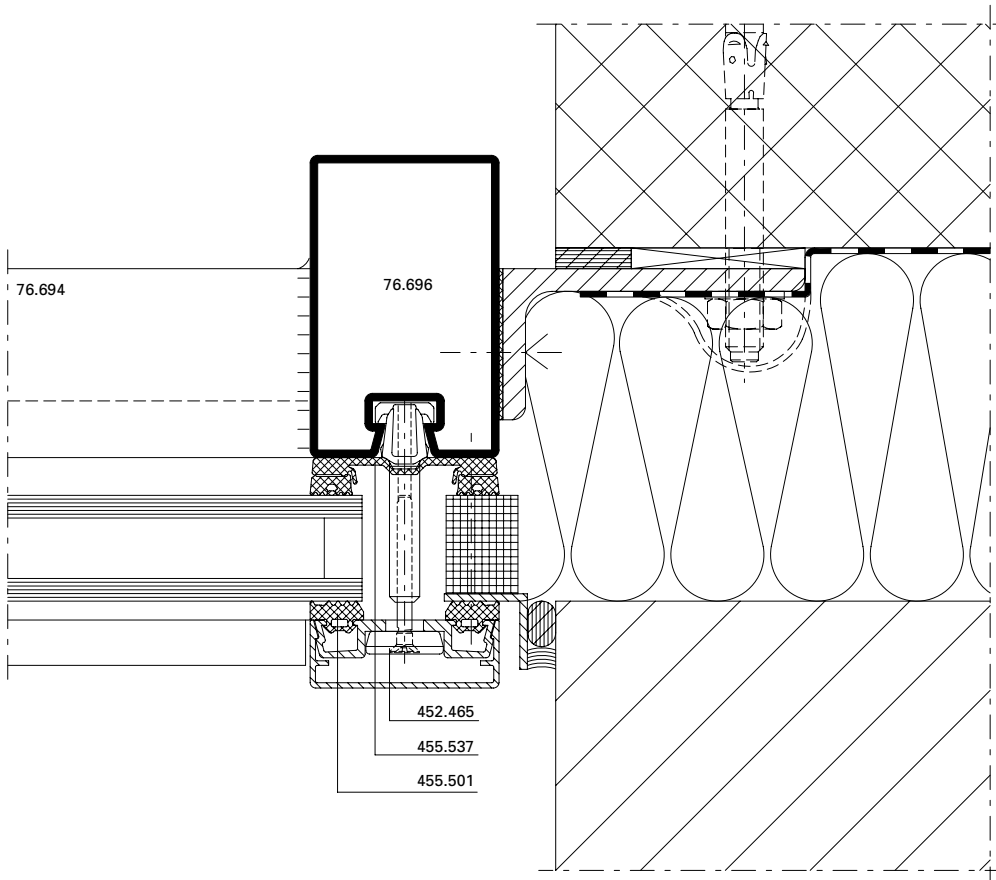

DXF DWG

D-510-A-001

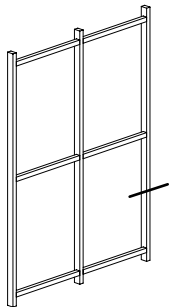
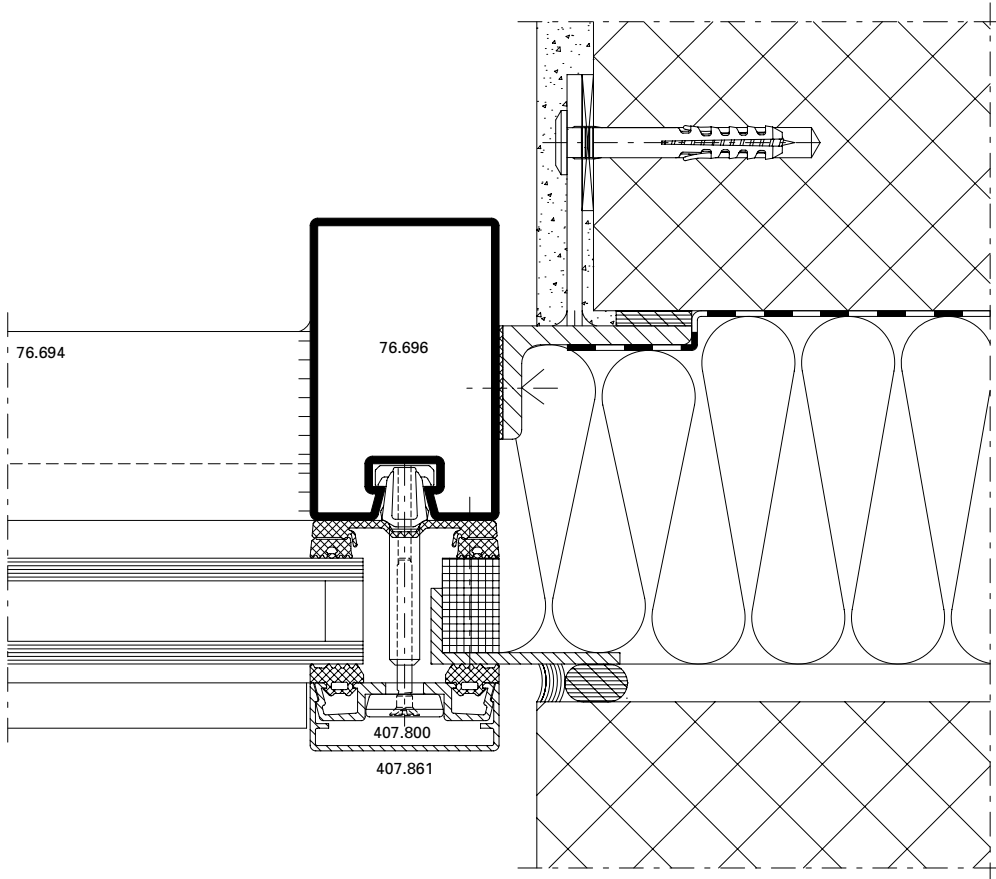

DXF DWG

D-510-A-002

Anschlüsse am Bau im Massstab 1:2
Raccords au mur à l'échelle 1:2
Attachment to structure on scale 1:2

VISS Fassade
VISS façade
VISS façade

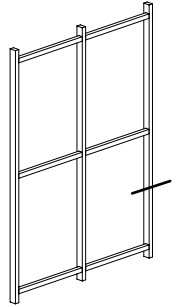
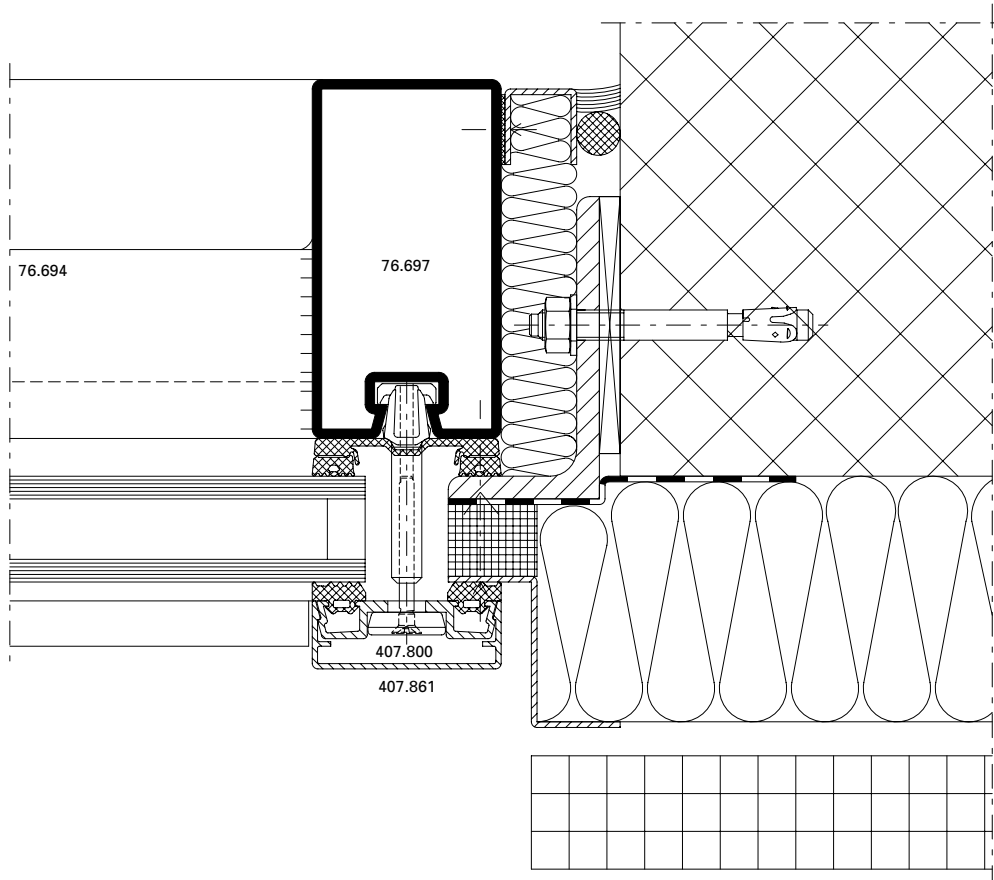

DXF **DWG**

D-510-A-003

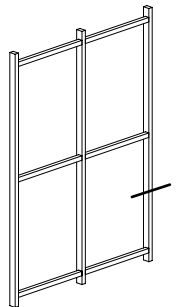
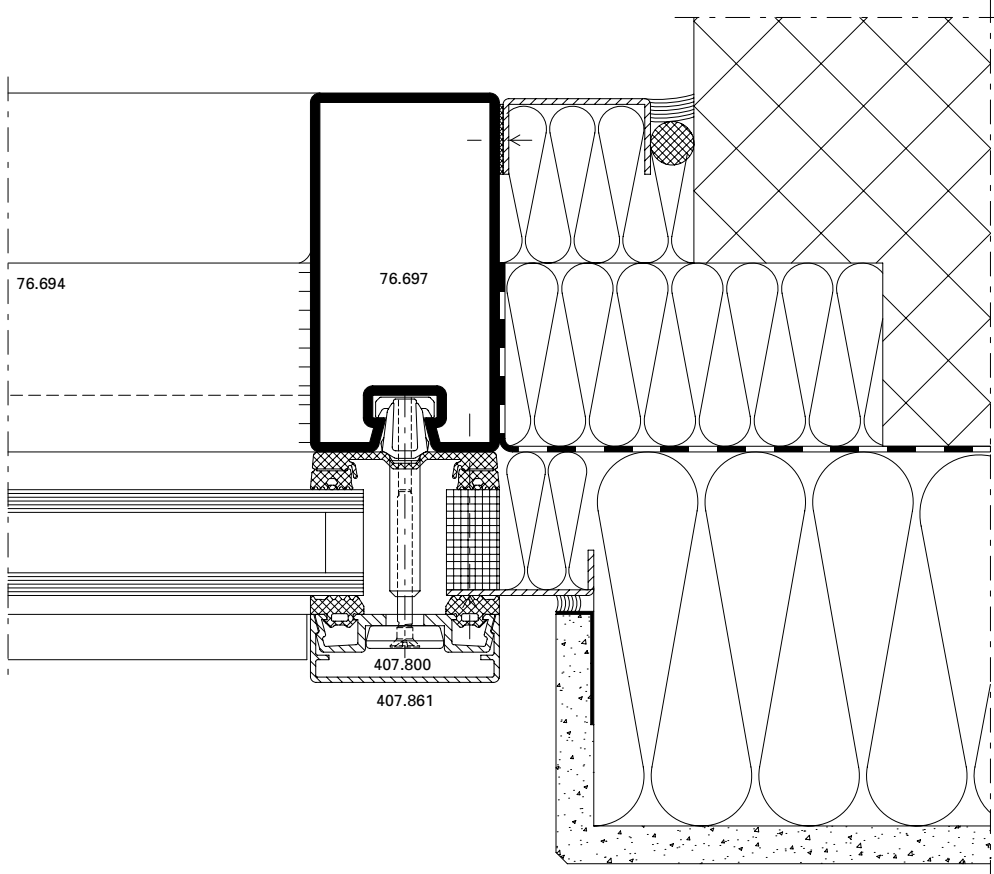

DXF **DWG**

D-510-A-004

Anschlüsse am Bau im Masstab 1:2
Raccords au mur à l'échelle 1:2
Attachment to structure on scale 1:2

VISS Fassade
VISS façade
VISS façade

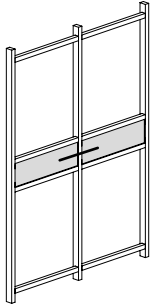
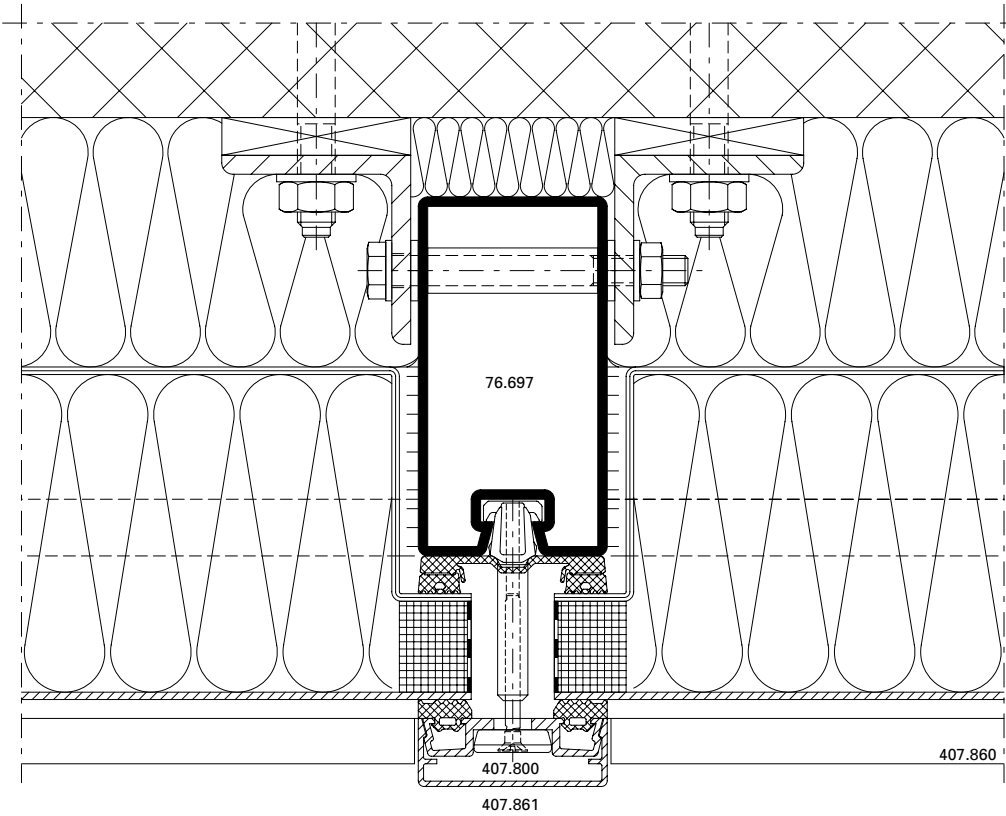

DXF **DWG**

D-510-A-005

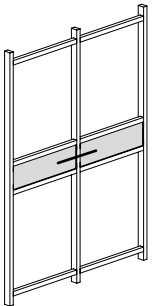
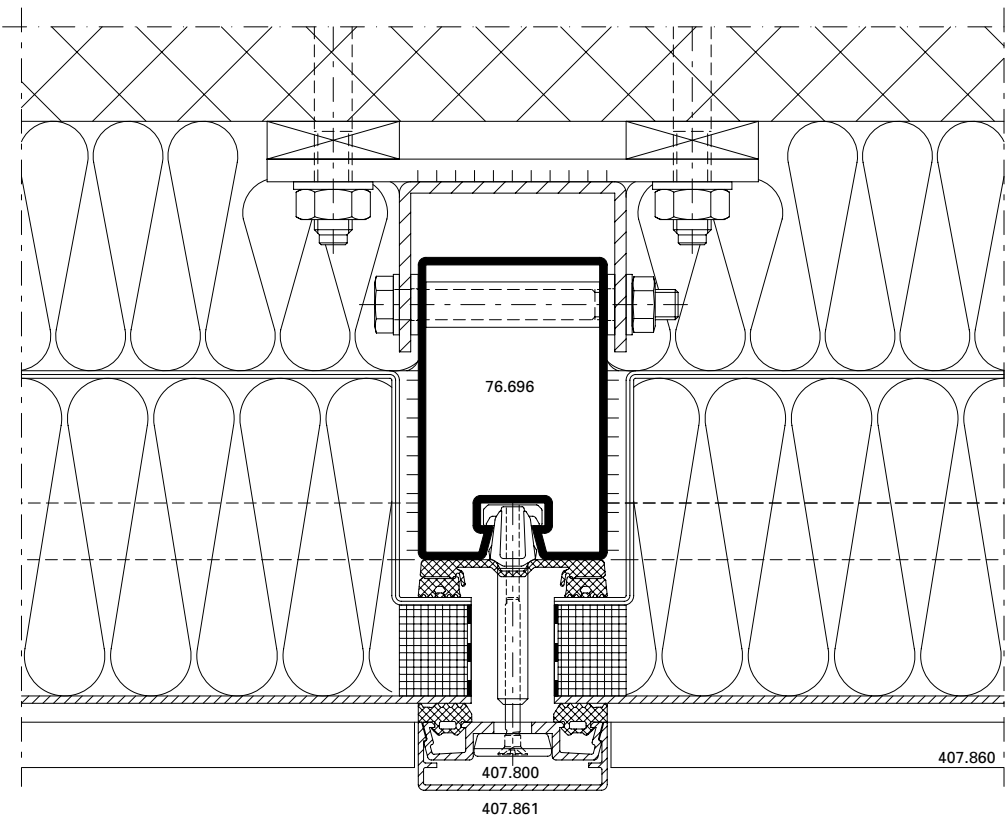

DXF **DWG**

D-510-A-006

Anschlüsse am Bau im Massstab 1:2
Raccords au mur à l'échelle 1:2
Attachment to structure on scale 1:2

VISS Fassade
VISS façade
VISS façade

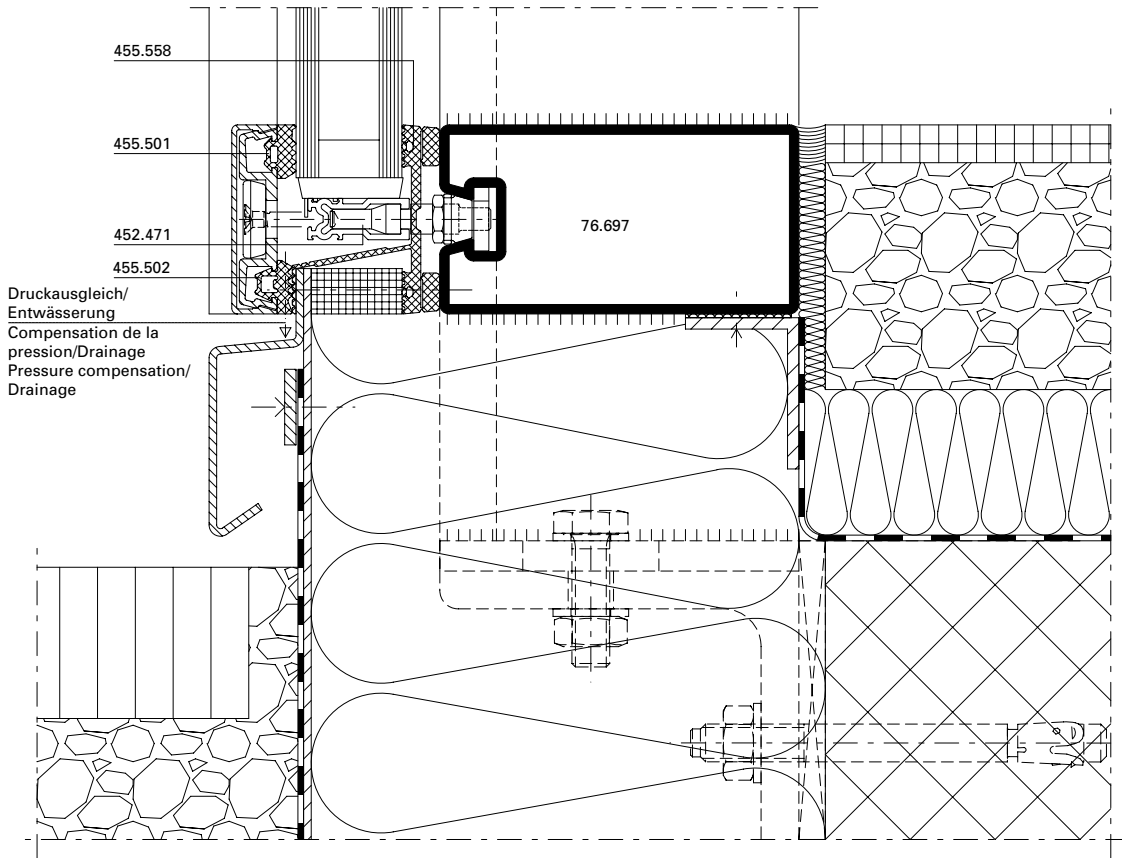

DXF DWG

D-510-A-007

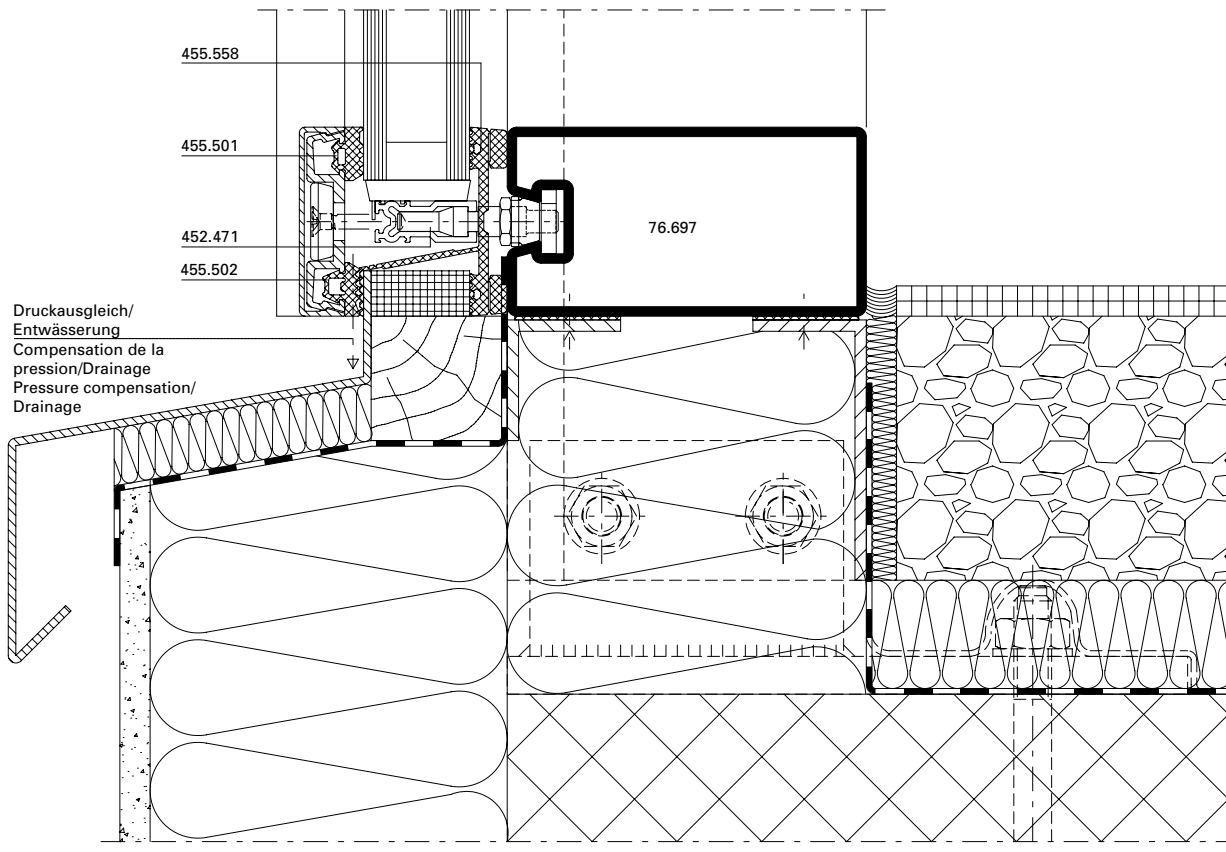

DXF DWG

D-510-A-008

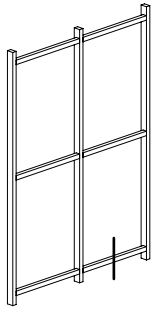
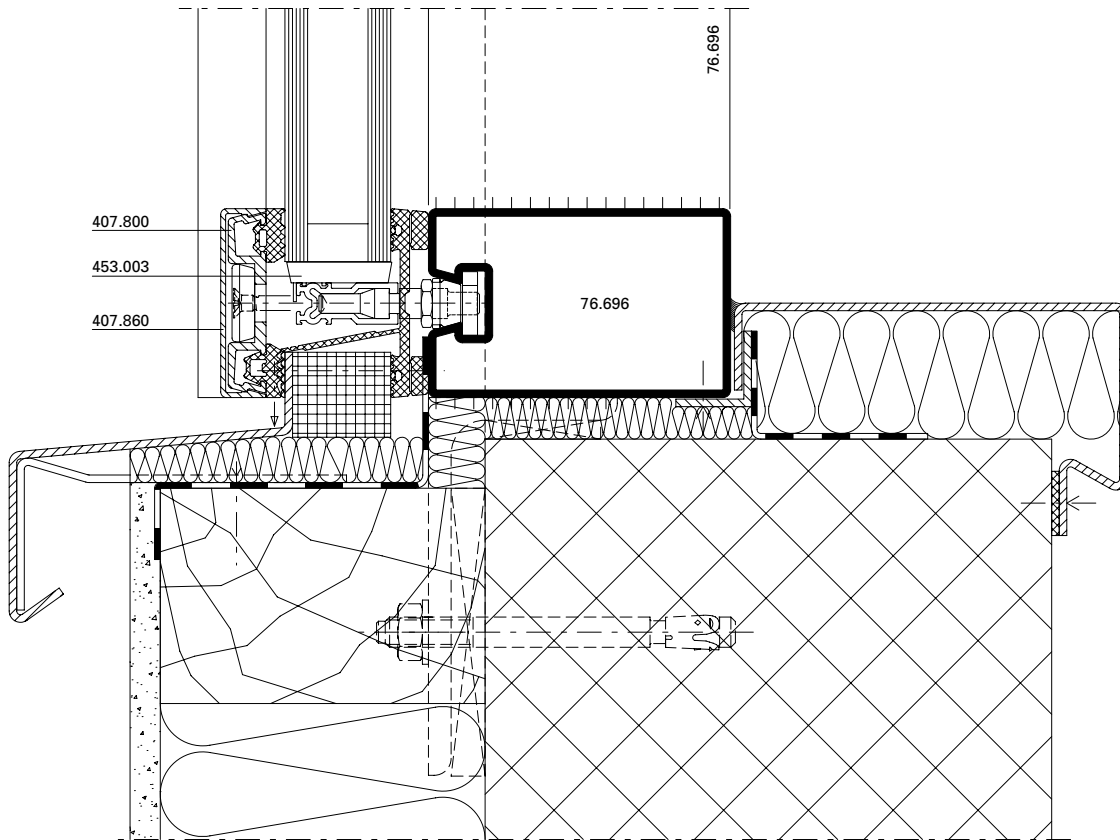

DXF DWG

D-510-A-009

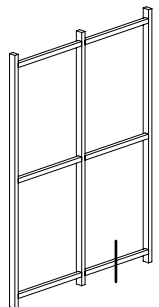
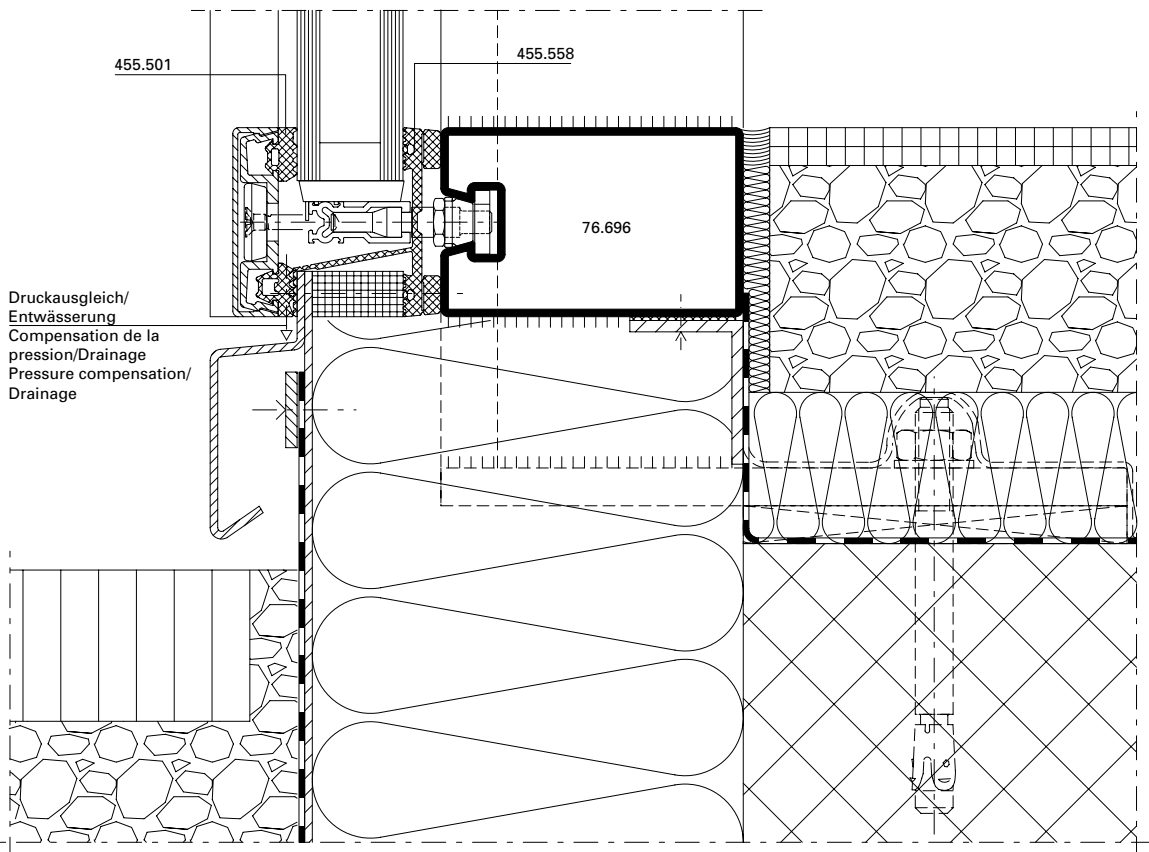

DXF DWG

D-510-A-010

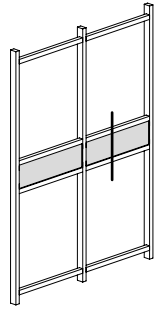
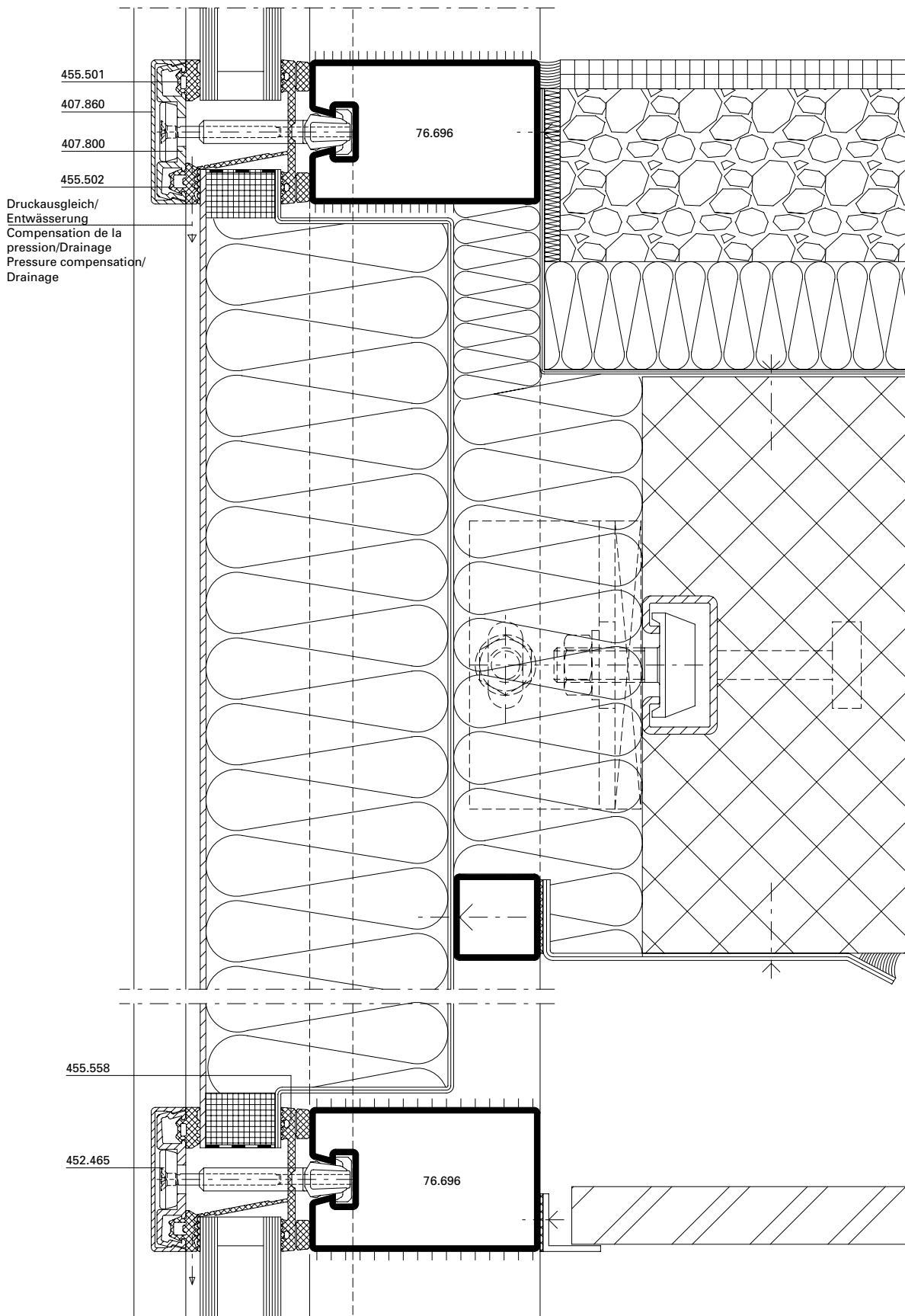

DXF DWG

D-510-A-011

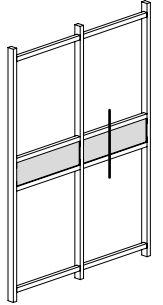
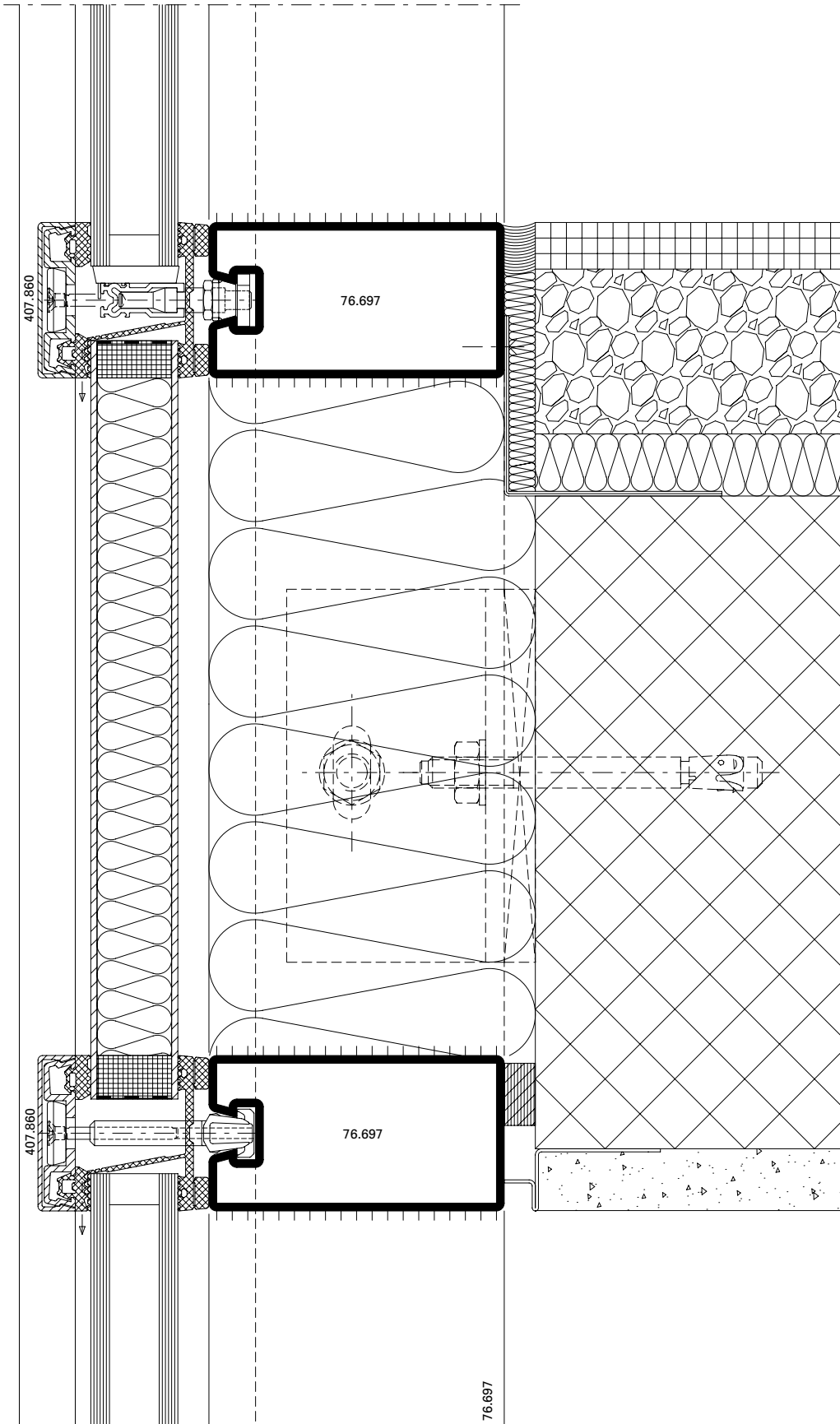

DXF **DWG**

D-510-A-012

Anschlüsse am Bau im Massstab 1:2
Raccords au mur à l'échelle 1:2
Attachment to structure on scale 1:2

VISS Fassade
VISS façade
VISS façade

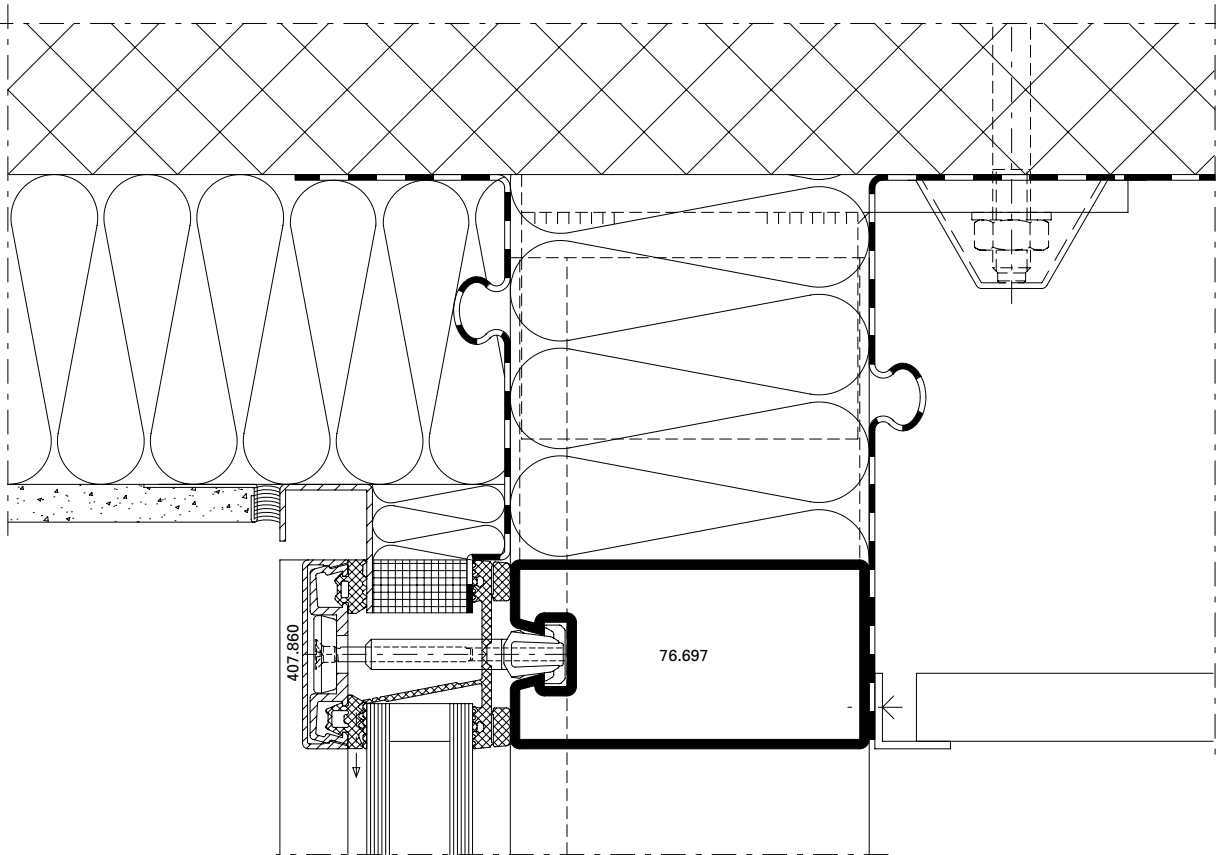

DXF **DWG**

D-510-A-013

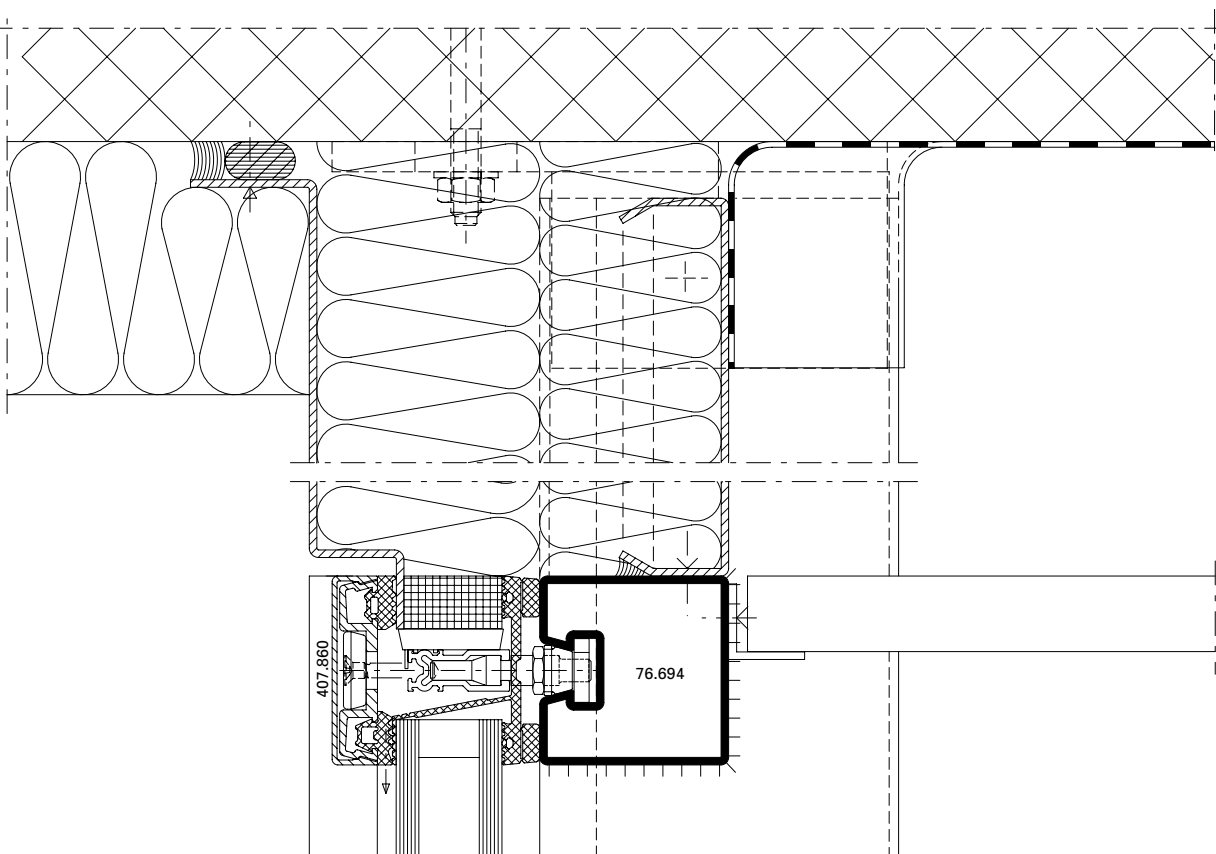

DXF **DWG**

D-510-A-014

Anschlüsse am Bau im Masstab 1:2
Raccords au mur à l'échelle 1:2
Attachment to structure on scale 1:2

VISS Fassade
VISS façade
VISS façade

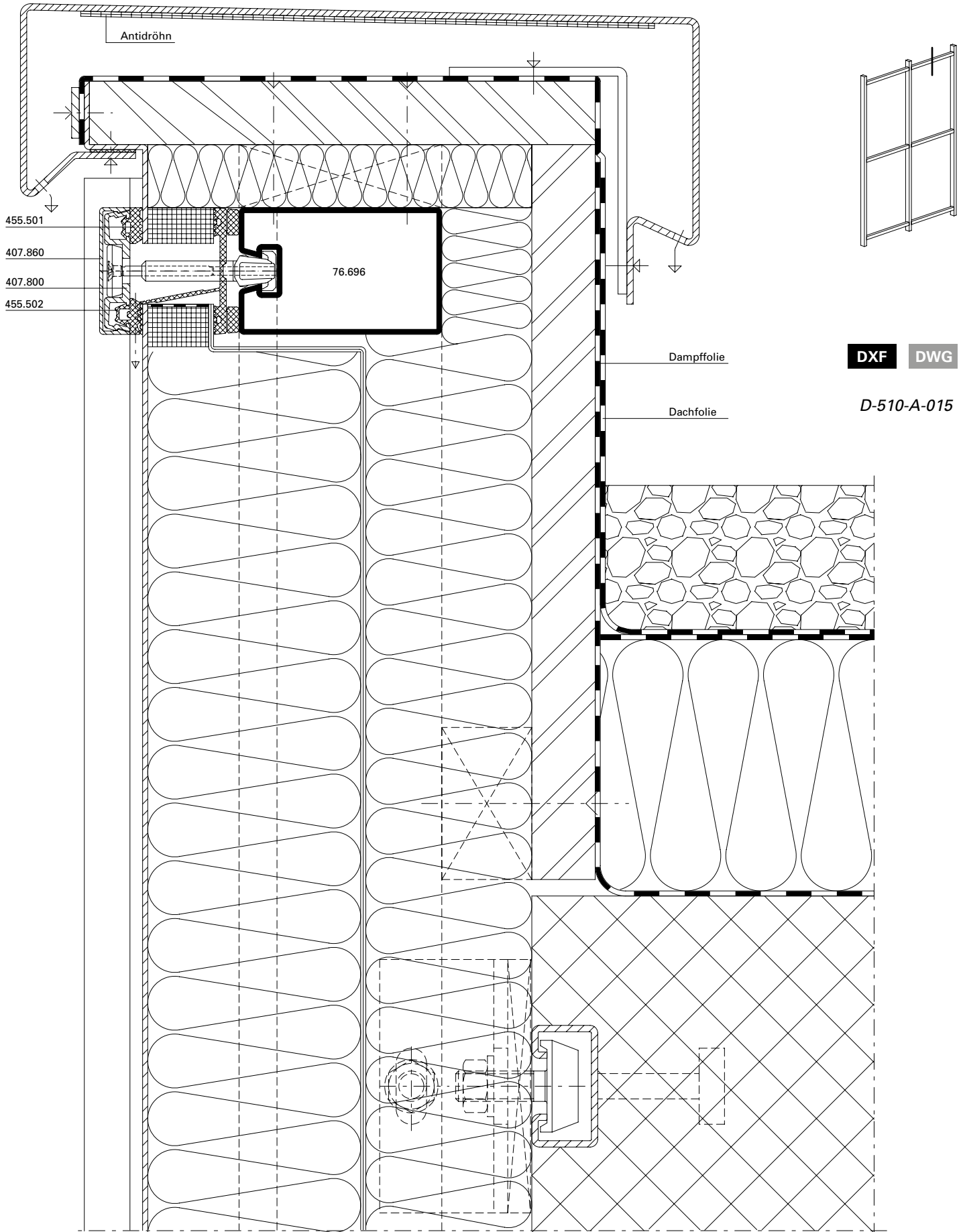

Sonnenschutz-Befestigung

Fixation pare-soleil

Sun protection fixation

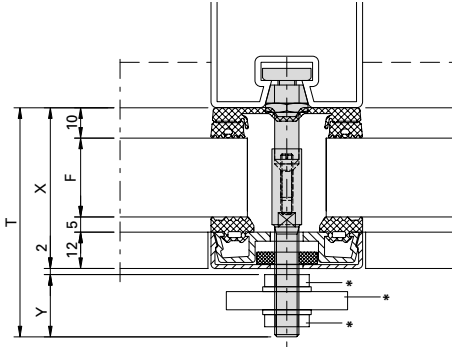

F	Anker Ancrage Anchor	Aufsatzbolzen Boulon de fixation Bolt	Deckprofil Profilé de recouvrement Cover section	X	Y	T	Fv N
6 - 14	452.550	452.557	12 mm	33 - 41	31 - 23	66	750
15 - 23	452.550			42 - 50	22 - 14	66	750
24 - 29	452.551			51 - 56	21 - 16	74	700
30 - 36	452.552			57 - 63	21 - 15	80	650
37 - 42	452.553			64 - 69	21 - 16	87	600
43 - 48	452.554			70 - 75	21 - 16	93	550

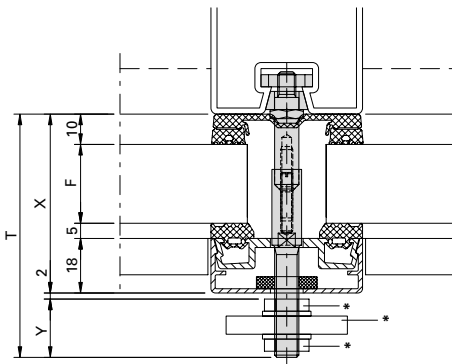

F	Anker Ancrage Anchor	Aufsatzbolzen Boulon de fixation Bolt	Deckprofil Profilé de recouvrement Cover section	X	Y	T	Fv N
6 - 14	452.550	452.557	18 mm	39 - 47	25 - 17	66	750
15 - 23	452.551			48 - 56	24 - 16	74	700
24 - 29	452.552			57 - 62	21 - 16	80	650
30 - 36	452.553			63 - 69	22 - 16	87	600
37 - 42	452.554			70 - 75	21 - 16	93	550
43 - 48	452.555			76 - 81	21 - 16	99	500

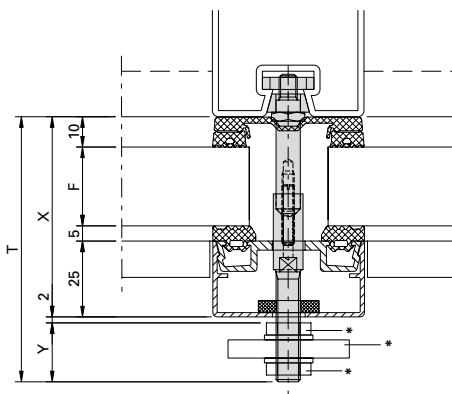

F	Anker Ancrage Anchor	Aufsatzbolzen Boulon de fixation Bolt	Deckprofil Profilé de recouvrement Cover section	X	Y	T	Fv N
6 - 14	452.551	452.557	25 mm	46 - 54	26 - 18	74	700
15 - 23	452.552			55 - 63	23 - 15	80	650
24 - 29	452.553			64 - 69	21 - 16	87	600
30 - 36	452.554			70 - 76	21 - 15	93	550
37 - 42	452.555			77 - 82	20 - 15	99	500
43 - 48	452.556			83 - 88	27 - 22	112	450

- * Anschlussplatte und Inox-Muttern M8 bauseits (Mutter selbstsichernd oder mit Federscheibe gesichert)
- * Plaque de raccordement et écrous Inox M8 au soin du métallier (écrous indesserrables ou bloqués par rondelle élastique)
- * Connection plate and M8 stainless steel nuts by the contractor (self-locking nut, or secured with spring washer).

Sonnenschutz-Befestigung

Fixation pare-soleil

Sun protection fixation

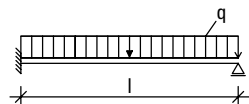
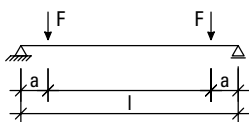
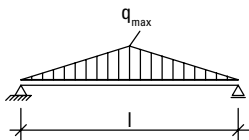
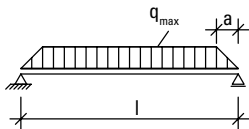
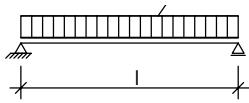

Belastungsangaben

F_v = siehe Tabellen Seite 22-74

F_n = 800 N (80 kg)

F_q = 0

Gilt für paarweise eingesetzte Bolzen.

Anzugsmoment:

Anker 4 Nm

Aufsatzbolzen 2,5 Nm

Indications de charge

F_v = voir tableaux page 22-74

F_n = 800 N (80 kg)

F_q = 0

Valables pour boulons montés par paires.

Couple de serrage::

Ancrage 4 Nm

Boulon de fixation 2,5 Nm

Load specifications

F_v = see tables, page 22-74

F_n = 800 N (80 kg)

F_q = 0

Applies for bolts inserted in pairs.

Tightening torque:

Anchor 4 Nm

Bolt 2.5 Nm

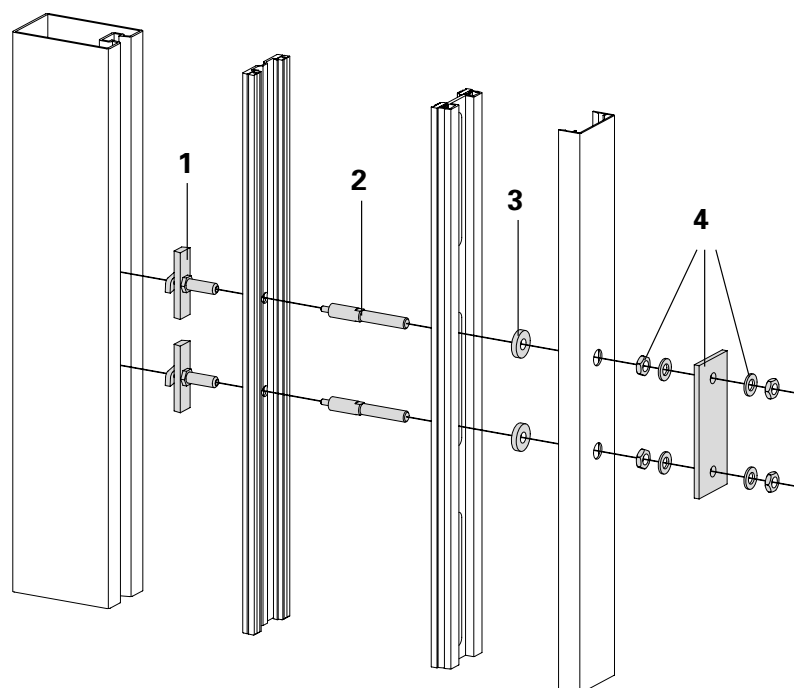

- 1 Anker (452.550-452.556)
- 2 Aufsatzbolzen (452.557)
- 3 Dichtring (aus 452.557)
- 4 Befestigungsplatte (bauseits)

- 1 Ancrage (452.550-452.556)
- 2 Boulon de fixation (452.557)
- 3 Bague d'étanchéité (de 452.557)
- 4 Plaque de fixation (au soin du métallier)

- 1 Anchor (452.550-452.556)
- 2 Bolt (452.557)
- 3 Gasket (from 452.557)
- 4 Fastening plate (customer-supplied)

Stossausbildungen Innendichtung

Jonctions joint intérieur

Inner gasket junctions

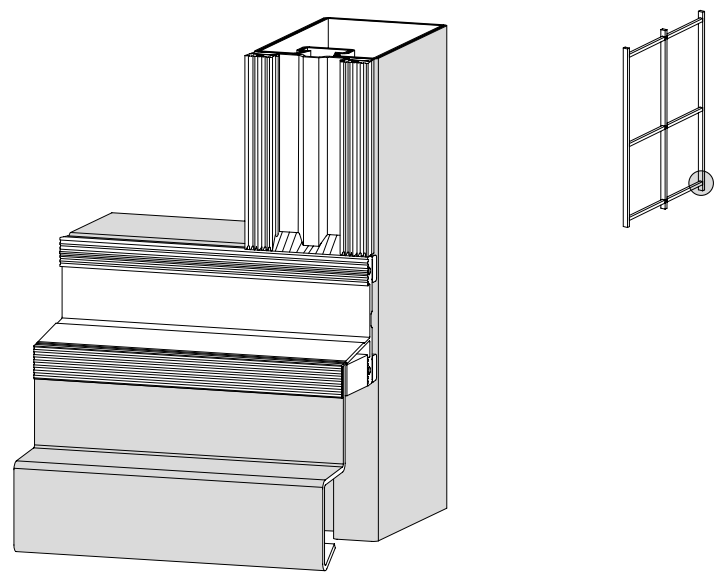
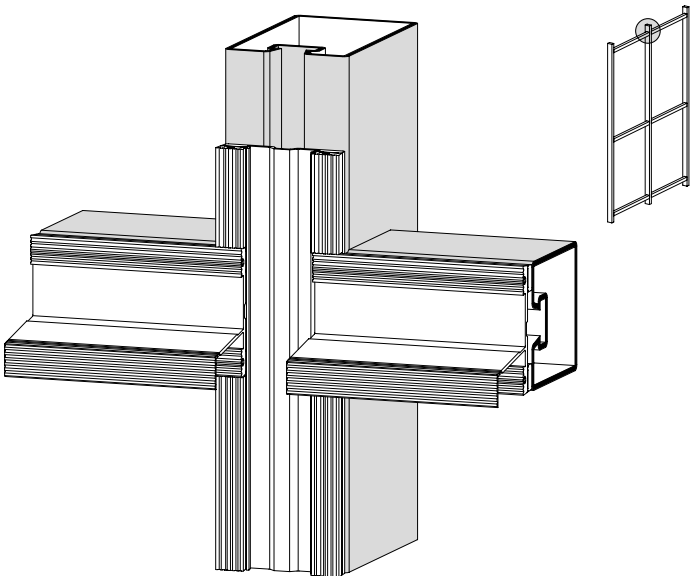
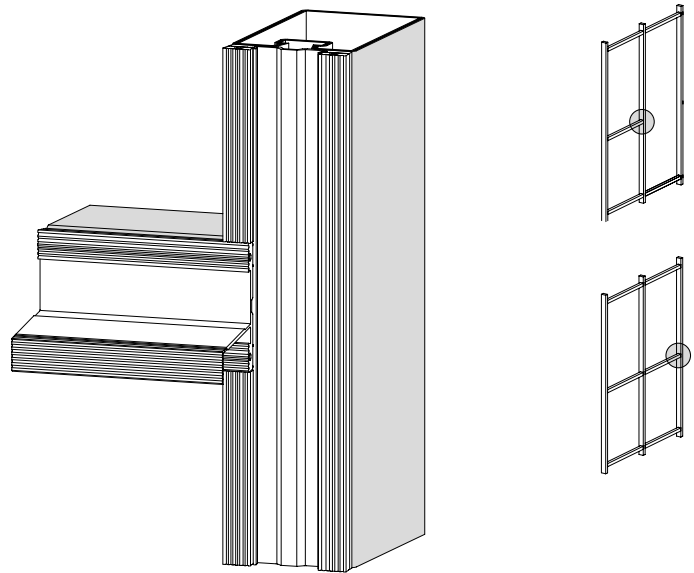
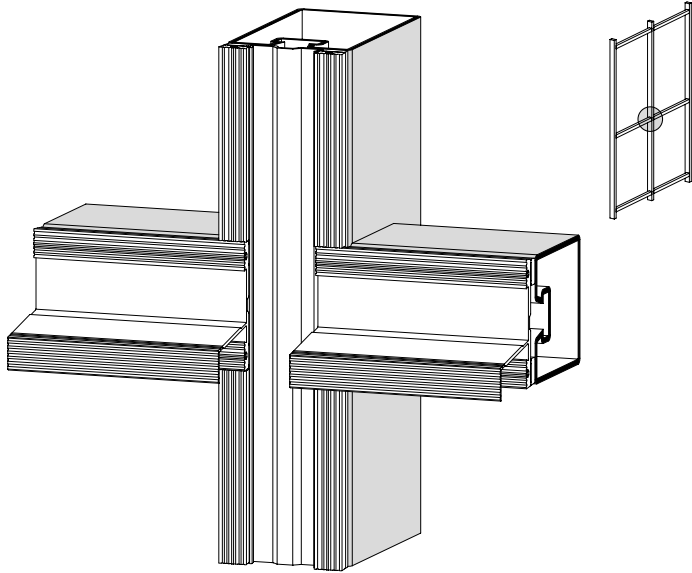

Stossausbildungen Innendichtung

Jonctions joint intérieure

Inner gasket junctions

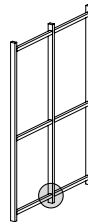
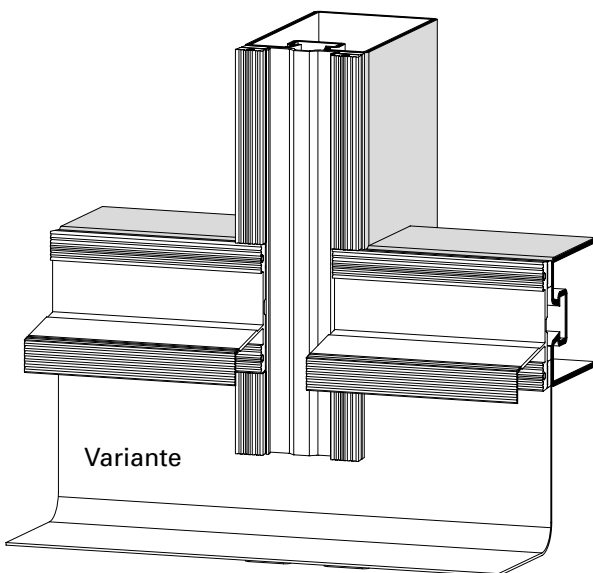
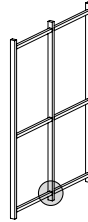
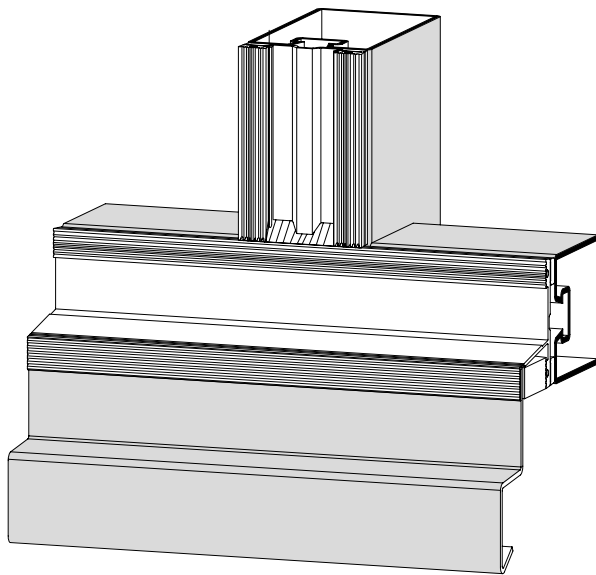

Glaseinstand

Prise en feuillure

Glass edge cover

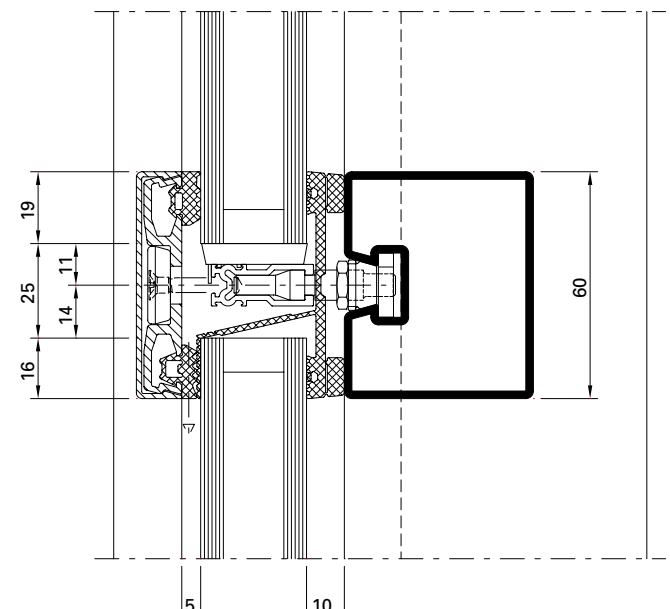
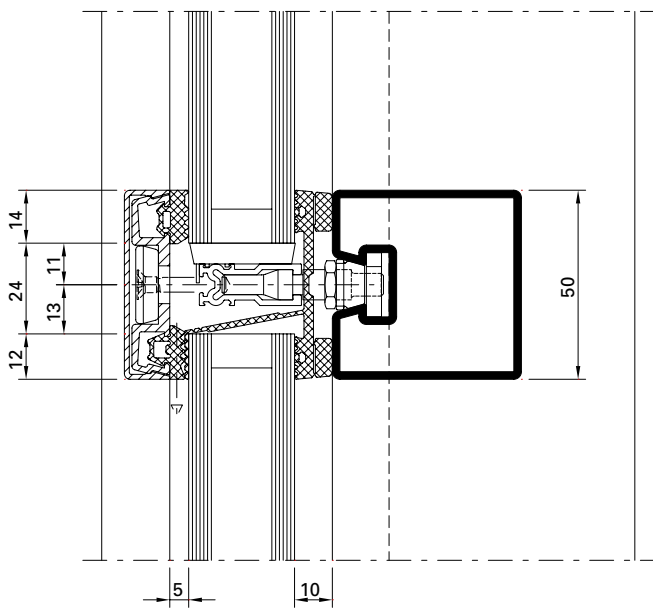
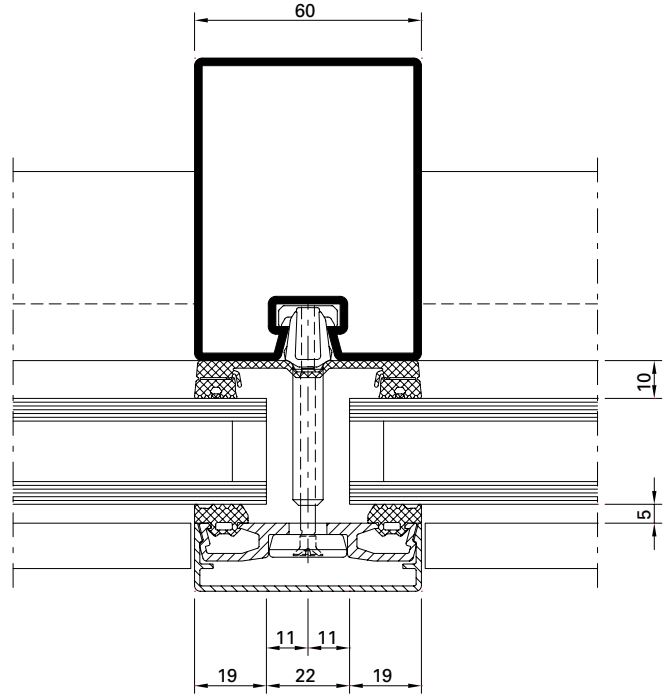
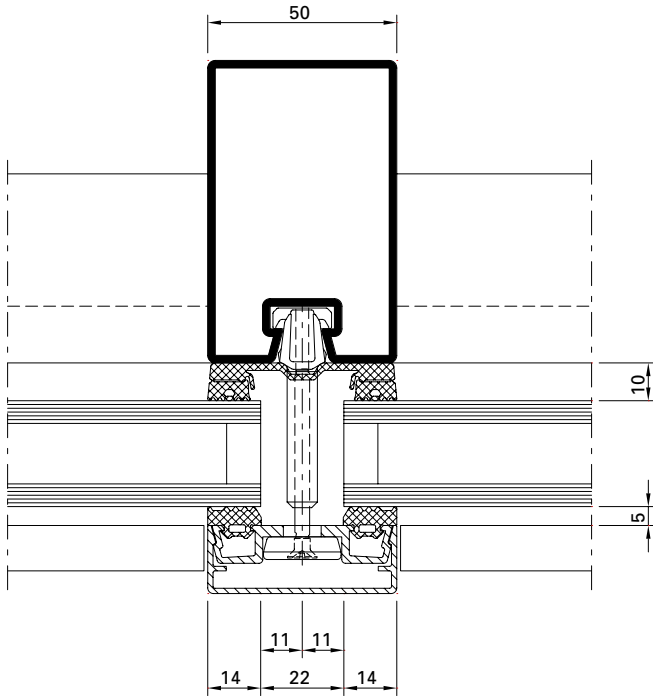

Verlangen Sie für die Verarbeitung und Montage der VISS-Systeme unsere ausführlichen Verarbeitungs- und Montage-Richtlinien.

Demandez notre brochure détaillée sur les directives d'usinage et de montage du systèmes VISS.

For processing and assembling the VISS systems, ask for our detailed Fabrication and Assembly Instructions.

Glaseinstand
Flaches Deckprofil

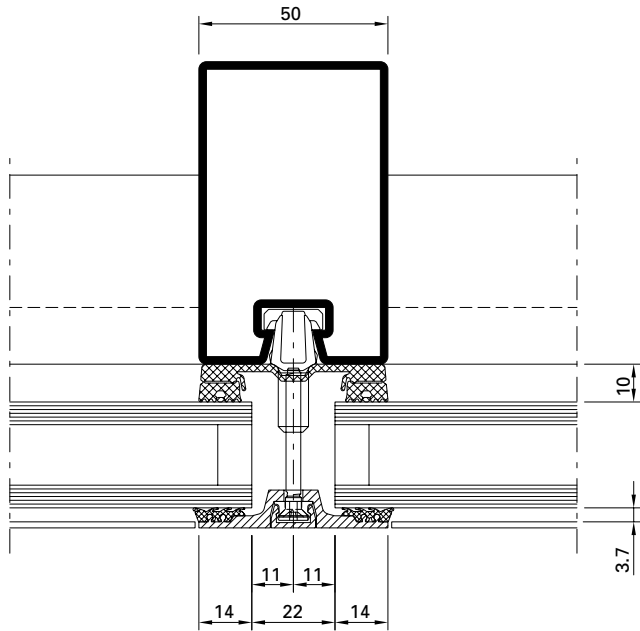

Prise en feuillure
Profilé de recouvrement plat

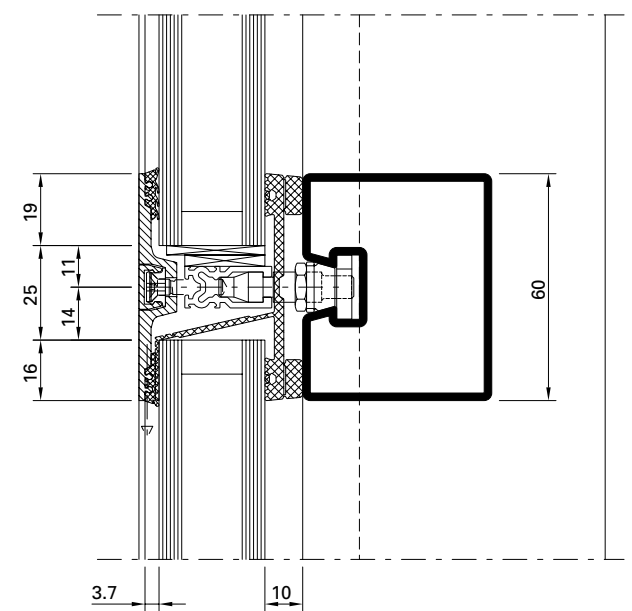
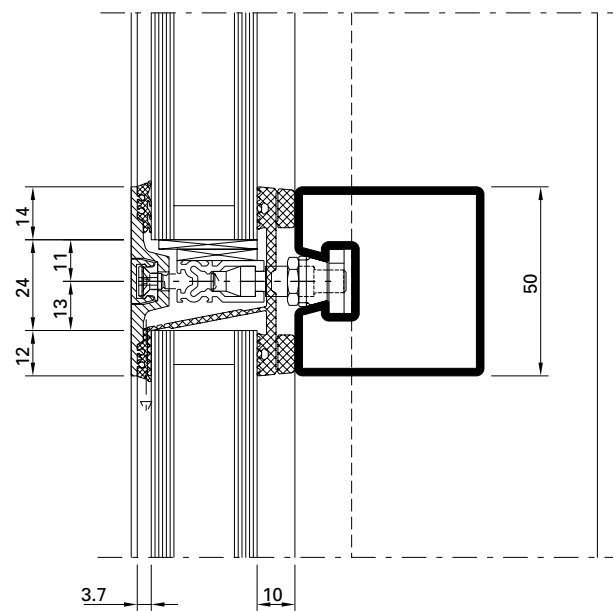
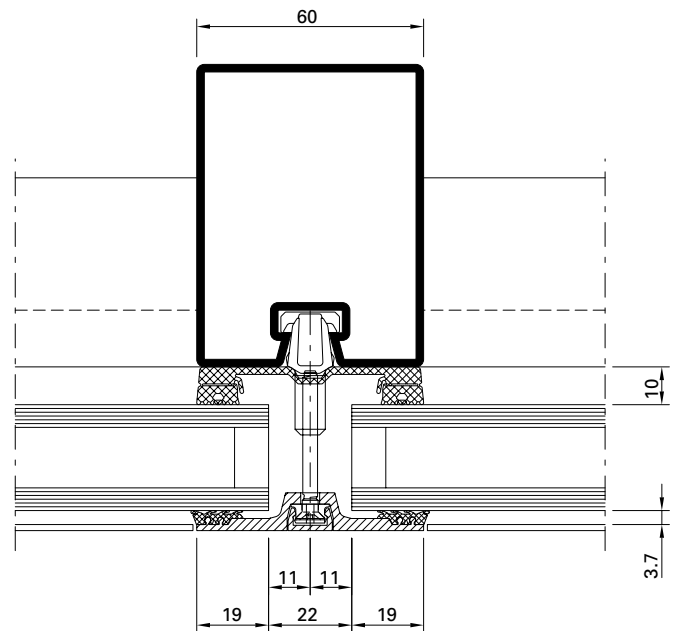

Glasfalz-Belüftung/
Glasfalz-Entwässerung

Ventilation de feuillures de verre/
Drainage de la feuillure à verre

Glazing rebate ventilation /
Glazing rebate drainage

Detail 1

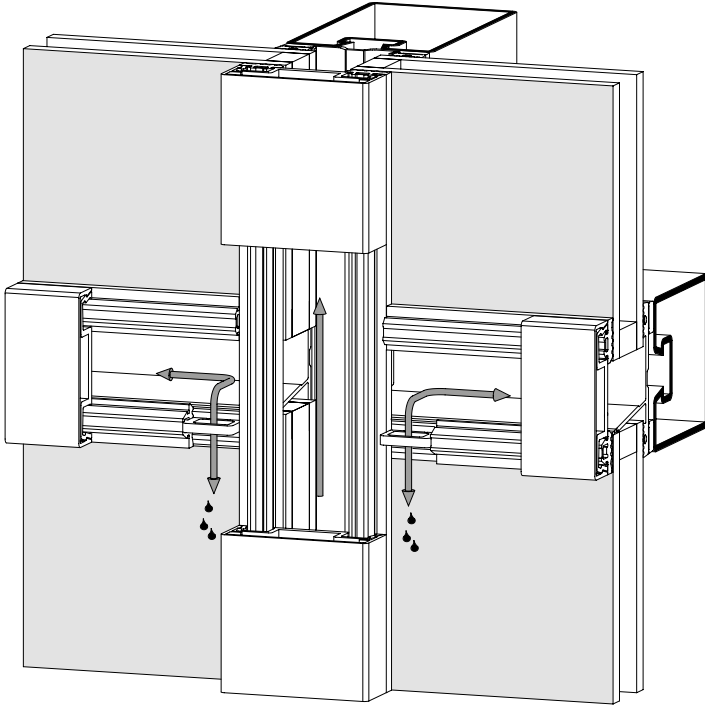

Detail 2

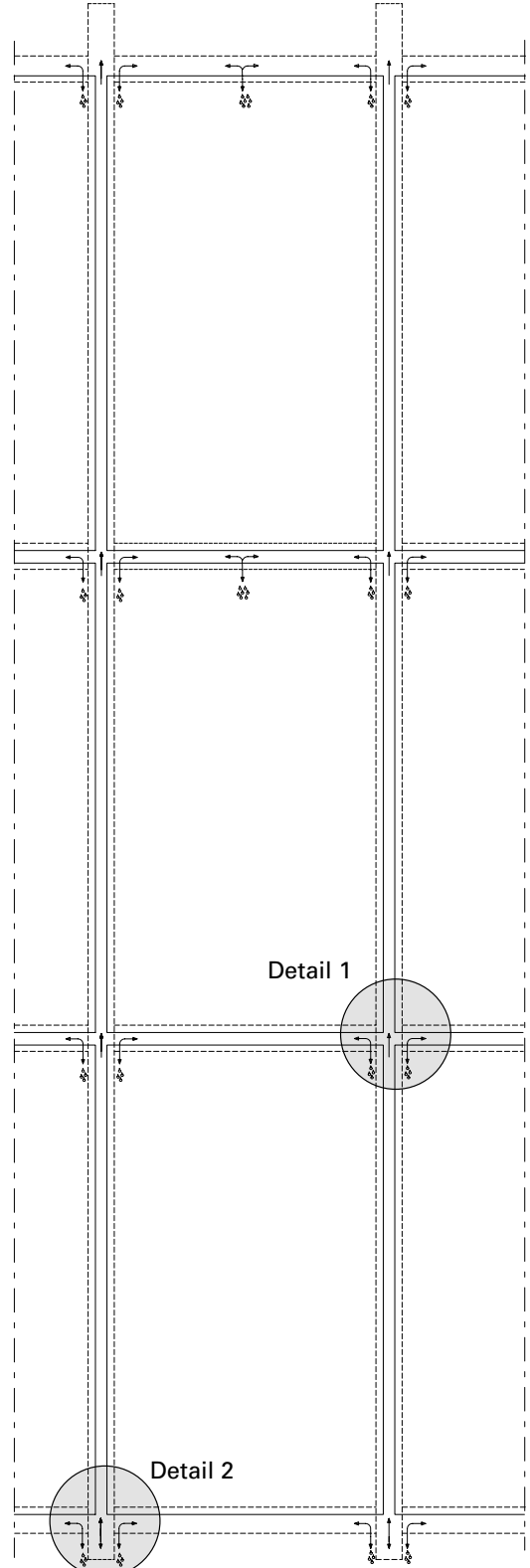
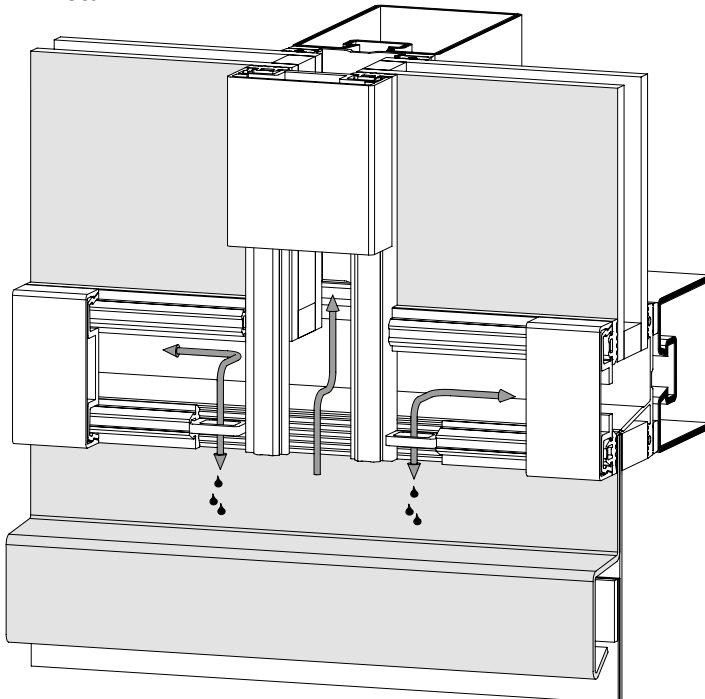

**Glasfalz-Belüftung/
Glasfalz-Entwässerung**

**Ventilation de feuillures de verre/
Drainage de la feuillure à verre**

**Glazing rebate ventilation /
Glazing rebate drainage**

Detail 3

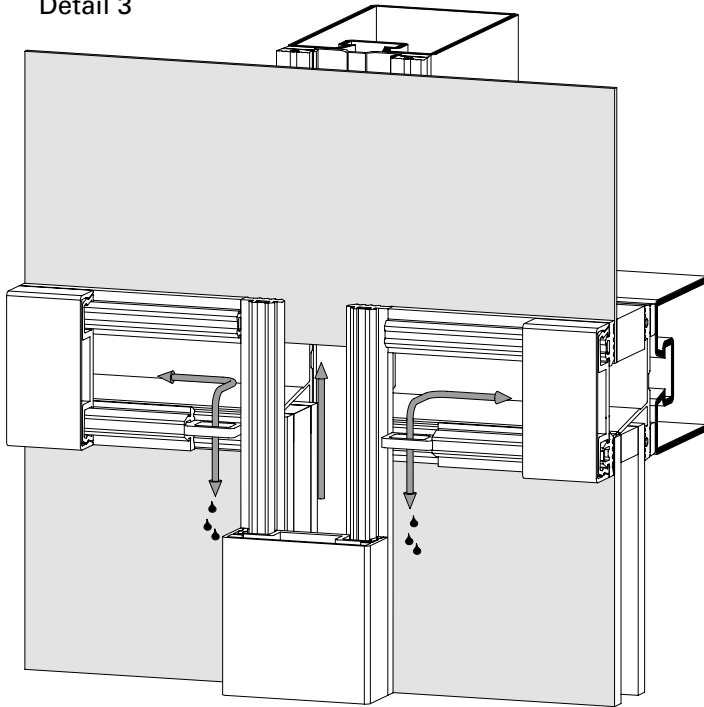

Detail 4

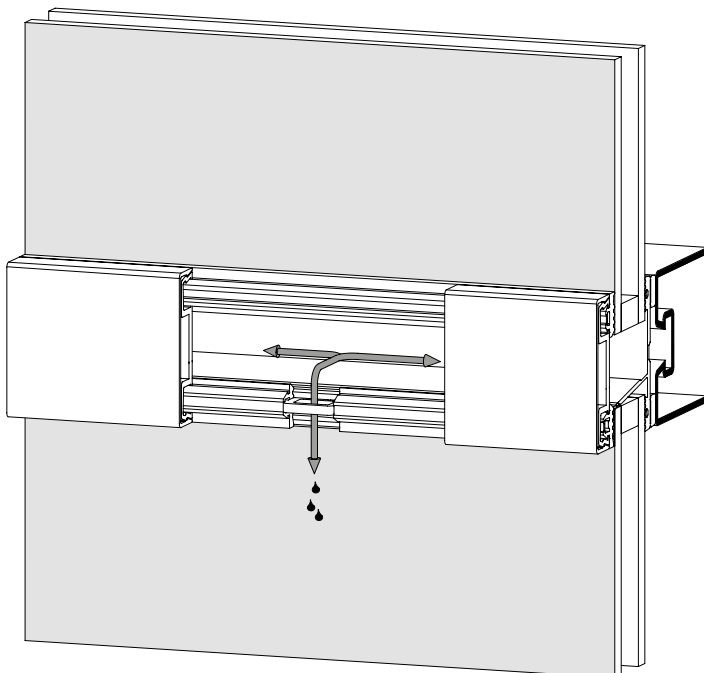

Detail 3

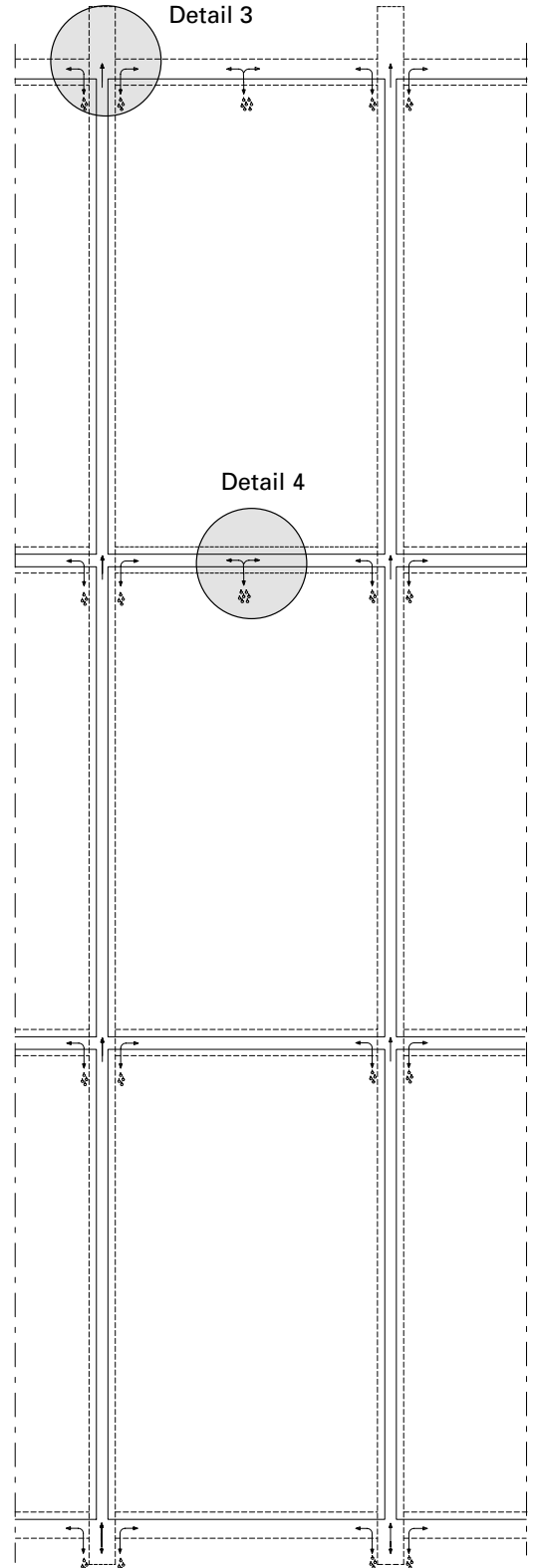

Detail 4

System-Hinweise

Remarques concernant les systèmes

System instructions

VISS Fassade

VISS façade

VISS façade

**VISS HI 50 mm
mit Dämmprofil**

U_f-Werte nach EN 10077-2

**VISS HI 50 mm
avec gaine isolante**

Valeurs U_f selon EN 10077-2

**VISS HI 50 mm
with insulating core**

U_f values according to 10077-2

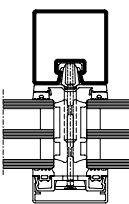
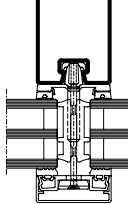
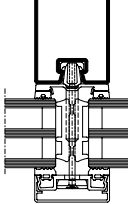
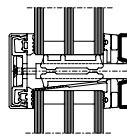
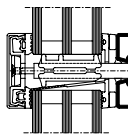
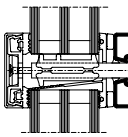
						
Glas Verre Glass	Pfosten 50/50 Montant 50/50 Mullion 50/50	Pfosten 50/95 Montant 50/95 Mullion 50/95	Pfosten 50/140 Montant 50/140 Mullion 50/140	Riegel 50/50 Traverse 50/50 Transom 50/50	Riegel 50/95 Traverse 50/95 Transom 50/95	Riegel 50/140 Traverse 50/140 Transom 50/140
30 mm	1,1 W/m²K	1,1 W/m²K	1,1 W/m²K	1,2 W/m²K	1,2 W/m²K	1,2 W/m²K
40 mm	0,94 W/m²K	0,94 W/m²K	0,94 W/m²K	1,1 W/m²K	1,1 W/m²K	1,1 W/m²K
50 mm	0,81 W/m²K	0,81 W/m²K	0,81 W/m²K	0,90 W/m²K	0,91 W/m²K	0,91 W/m²K
60 mm	0,72 W/m²K	0,72 W/m²K	0,72 W/m²K	0,83 W/m²K	0,83 W/m²K	0,83 W/m²K
70 mm	0,67 W/m²K	0,67 W/m²K	0,67 W/m²K	0,78 W/m²K	0,79 W/m²K	0,79 W/m²K

**Der Einfluss der Schrauben-
befestigung in Höhe von 0.14 W/m²K
ist berücksichtigt.**

**L'influence de la fixation à vis de
0.14 W/m²K est prise en compte.**

**The 0.14 W/m²K influence of the
screw fixing is taken into account.**

System-Hinweise

Remarques concernant les systèmes

System instructions

VISS Fassade

VISS façade

VISS façade

**VISS HI 60 mm
mit Dämmprofil**

U_f-Werte nach EN 10077-2

**VISS HI 60 mm
avec gaine isolante**

Valeurs U_f selon EN 10077-2

**VISS HI 60 mm
with insulating core**

U_f values according to 10077-2

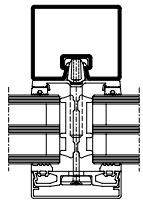
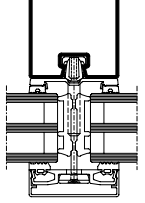
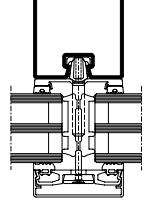
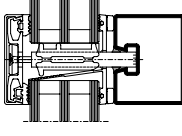
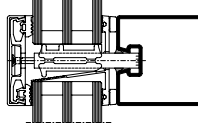
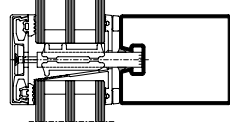
						
Glas Verre Glass	Pfosten 60/50 Montant 60/50 Mullion 60/50	Pfosten 60/100 Montant 60/100 Mullion 60/100	Pfosten 60/150 Montant 60/150 Mullion 60/150	Riegel 60/50 Traverse 60/50 Transom 60/50	Riegel 60/100 Traverse 60/100 Transom 60/100	Riegel 60/150 Traverse 60/150 Transom 60/150
30 mm	1,1 W/m²K	1,1 W/m²K	1,1 W/m²K	1,1 W/m²K	1,2 W/m²K	1,2 W/m²K
40 mm	0,91 W/m²K	0,91 W/m²K	0,91 W/m²K	0,98 W/m²K	0,98 W/m²K	0,98 W/m²K
50 mm	0,79 W/m²K	0,80 W/m²K	0,81 W/m²K	0,88 W/m²K	0,89 W/m²K	0,90 W/m²K
60 mm	0,71 W/m²K	0,71 W/m²K	0,71 W/m²K	0,80 W/m²K	0,80 W/m²K	0,80 W/m²K
70 mm	0,65 W/m²K	0,66 W/m²K	0,66 W/m²K	0,75 W/m²K	0,76 W/m²K	0,76 W/m²K

Glas Verre Glass	76.140 Pfosten 60/180 Montant 60/180 Mullion 60/180	76.141 Pfosten 60/220 Montant 60/220 Mullion 60/220	76.142 Pfosten 60/280 Montant 60/280 Mullion 60/280	76.140 Riegel 60/180 Traverse 60/180 Transom 60/180	76.141 Riegel 60/220 Traverse 60/220 Transom 60/220	76.142 Riegel 60/280 Traverse 60/280 Transom 60/280
50 mm	0,81 W/m²K	0,81 W/m²K	0,81 W/m²K	0,90 W/m²K	0,90 W/m²K	0,90 W/m²K
70 mm	0,65 W/m²K	0,65 W/m²K	0,65 W/m²K	0,75 W/m²K	0,74 W/m²K	0,74 W/m²K

Der Einfluss der Schrauben-
befestigung in Höhe von 0.14 W/m²K
ist berücksichtigt.

L'influence de la fixation à vis de
0.14 W/m²K est prise en compte.

The 0.14 W/m²K influence of the
screw fixing is taken into account.

System-Hinweise

Remarques concernant les systèmes

System instructions

VISS Fassade

VISS façade

VISS façade

**VISS HI 50 mm
mit Dämmprofil
Flaches Deckprofil**

U_f-Werte nach EN 10077-2

**VISS HI 50 mm
avec gaine isolante
Profilé de recouvrement plat**

Valeurs U_f selon EN 10077-2

**VISS HI 50 mm
with insulating core
Flat cover cap**

U_f values according to 10077-2

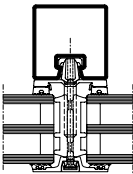
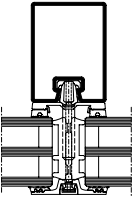
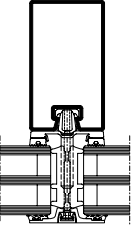
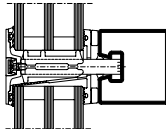
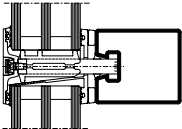
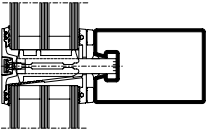
						
Glas Verre Glass	Pfosten 50/50 Montant 50/50 Mullion 50/50	Pfosten 50/95 Montant 50/95 Mullion 50/95	Pfosten 50/140 Montant 50/140 Mullion 50/140	Riegel 50/50 Traverse 50/50 Transom 50/50	Riegel 50/95 Traverse 50/95 Transom 50/95	Riegel 50/140 Traverse 50/140 Transom 50/140
30 mm	1,2 W/m²K	1,2 W/m²K	1,2 W/m²K	1,3 W/m²K	1,3 W/m²K	1,3 W/m²K
40 mm	1,0 W/m²K	1,0 W/m²K	1,0 W/m²K	1,1 W/m²K	1,1 W/m²K	1,1 W/m²K
50 mm	0,83 W/m²K	0,84 W/m²K	0,84 W/m²K	0,93 W/m²K	0,94 W/m²K	0,95 W/m²K
60 mm	0,79 W/m²K	0,79 W/m²K	0,79 W/m²K	0,88 W/m²K	0,88 W/m²K	0,88 W/m²K
70 mm	0,68 W/m²K	0,69 W/m²K	0,69 W/m²K	0,79 W/m²K	0,79 W/m²K	0,79 W/m²K

**Der Einfluss der Schrauben-
befestigung in Höhe von 0.14 W/m²K
ist berücksichtigt.**

**L'influence de la fixation à vis de
0.14 W/m²K est prise en compte.**

**The 0.14 W/m²K influence of the
screw fixing is taken into account.**

System-Hinweise

Remarques concernant les systèmes

System instructions

VISS Fassade

VISS façade

VISS façade

**VISS HI 60 mm
mit Dämmprofil
Flaches Deckprofil**

U_f-Werte nach EN 10077-2

**VISS HI 60 mm
avec gaine isolante
Profilé de recouvrement plat**

Valeurs U_f selon EN 10077-2

**VISS HI 60 mm
with insulating core
Flat cover cap**

U_f values according to 10077-2

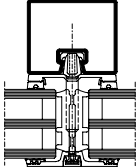
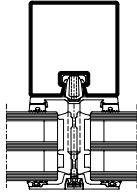
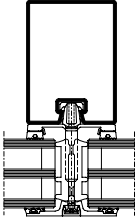
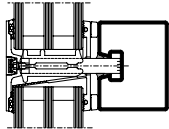
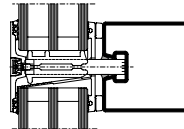
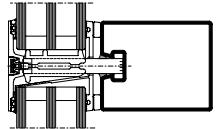
						
Glas Verre Glass	Pfofen 60/50 Montant 60/50 Mullion 60/50	Pfofen 60/100 Montant 60/100 Mullion 60/100	Pfofen 60/150 Montant 60/150 Mullion 60/150	Riegel 60/50 Traverse 60/50 Transom 60/50	Riegel 60/100 Traverse 60/100 Transom 60/100	Riegel 60/150 Traverse 60/150 Transom 60/150
30 mm	1,14 W/m²K	1,16 W/m²K	1,16 W/m²K	1,23 W/m²K	1,26 W/m²K	1,26 W/m²K
40 mm	0,97 W/m²K	0,97 W/m²K	0,97 W/m²K	1,06 W/m²K	1,06 W/m²K	1,06 W/m²K
50 mm	0,80 W/m²K	0,81 W/m²K	0,81 W/m²K	0,92 W/m²K	0,93 W/m²K	0,93 W/m²K
60 mm	0,74 W/m²K	0,74 W/m²K	0,74 W/m²K	0,83 W/m²K	0,83 W/m²K	0,83 W/m²K
70 mm	0,65 W/m²K	0,66 W/m²K	0,66 W/m²K	0,76 W/m²K	0,76 W/m²K	0,77 W/m²K

Glas Verre Glass	76.140 Pfofen 60/180 Montant 60/180 Mullion 60/180	76.141 Pfofen 60/220 Montant 60/220 Mullion 60/220	76.142 Pfofen 60/280 Montant 60/280 Mullion 60/280	76.140 Riegel 60/180 Traverse 60/180 Transom 60/180	76.141 Riegel 60/220 Traverse 60/220 Transom 60/220	76.142 Riegel 60/280 Traverse 60/280 Transom 60/280
50 mm	0,81 W/m²K	0,81 W/m²K	0,82 W/m²K	0,93 W/m²K	0,93 W/m²K	0,93 W/m²K
70 mm	0,66 W/m²K	0,66 W/m²K	0,66 W/m²K	0,77 W/m²K	0,77 W/m²K	0,77 W/m²K

Der Einfluss der Schrauben-
befestigung in Höhe von 0.14 W/m²K
ist berücksichtigt.

L'influence de la fixation à vis de
0.14 W/m²K est prise en compte.

The 0.14 W/m²K influence of the
screw fixing is taken into account.

System-Hinweise

Remarques concernant les systèmes

System instructions

VISS Fassade

VISS façade

VISS façade

VISS 50 mm

U_f-Werte nach EN 10077-2

VISS 50 mm

Valeurs U_f selon EN 10077-2

VISS 50 mm

U_f values according to 10077-2

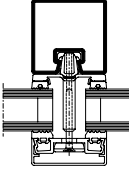
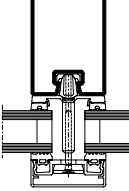
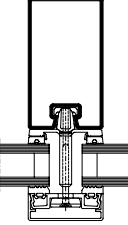
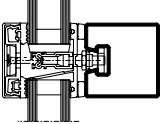
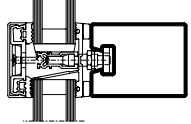
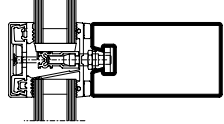
						
Glas Verre Glass	Pfosten 50/50 Montant 50/50 Mullion 50/50	Pfosten 50/95 Montant 50/95 Mullion 50/95	Pfosten 50/140 Montant 50/140 Mullion 50/140	Riegel 50/50 Traverse 50/50 Transom 50/50	Riegel 50/95 Traverse 50/95 Transom 50/95	Riegel 50/140 Traverse 50/140 Transom 50/140
20 mm	1,9 W/m²K	1,9 W/m²K	1,9 W/m²K	1,8 W/m²K	1,8 W/m²K	1,8 W/m²K
30 mm	1,7 W/m²K	1,8 W/m²K	1,8 W/m²K	1,6 W/m²K	1,6 W/m²K	1,6 W/m²K
40 mm	1,7 W/m²K	1,7 W/m²K	1,7 W/m²K	1,5 W/m²K	1,5 W/m²K	1,5 W/m²K
50 mm	1,5 W/m²K	1,6 W/m²K	1,6 W/m²K	1,4 W/m²K	1,4 W/m²K	1,4 W/m²K
60 mm	1,5 W/m²K	1,5 W/m²K	1,5 W/m²K	1,4 W/m²K	1,4 W/m²K	1,4 W/m²K
70 mm	1,4 W/m²K	1,5 W/m²K	1,5 W/m²K	1,4 W/m²K	1,4 W/m²K	1,4 W/m²K

Der Einfluss der Schraubenbefestigung in Höhe von 0.14 W/m²K ist berücksichtigt.

L'influence de la fixation à vis de 0.14 W/m²K est prise en compte.

The 0.14 W/m²K influence of the screw fixing is taken into account.

System-Hinweise

Remarques concernant les systèmes

System instructions

VISS Fassade

VISS façade

VISS façade

VISS 60 mm

U_f-Werte nach EN 10077-2

VISS 60 mm

Valeurs U_f selon EN 10077-2

VISS 60 mm

U_f values according to 10077-2

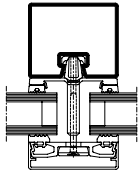
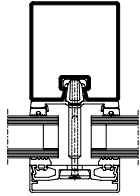
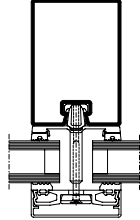
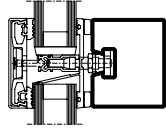
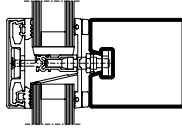
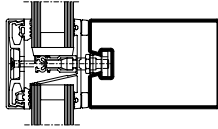
						
Glas Verre Glass	Pfosten 60/50 Montant 60/50 Mullion 60/50	Pfosten 60/100 Montant 60/100 Mullion 60/100	Pfosten 60/150 Montant 60/150 Mullion 60/150	Riegel 60/50 Traverse 60/50 Transom 60/50	Riegel 60/100 Traverse 60/100 Transom 60/100	Riegel 60/150 Traverse 60/150 Transom 60/150
20 mm	1,8 W/m ² K	1,8 W/m ² K	1,8 W/m ² K	1,7 W/m ² K	1,7 W/m ² K	1,7 W/m ² K
30 mm	1,6 W/m ² K	1,6 W/m ² K	1,6 W/m ² K	1,5 W/m ² K	1,5 W/m ² K	1,5 W/m ² K
40 mm	1,5 W/m ² K	1,5 W/m ² K	1,5 W/m ² K	1,4 W/m ² K	1,4 W/m ² K	1,4 W/m ² K
50 mm	1,4 W/m ² K	1,4 W/m ² K	1,4 W/m ² K	1,3 W/m ² K	1,3 W/m ² K	1,3 W/m ² K
60 mm	1,3 W/m ² K	1,3 W/m ² K	1,3 W/m ² K	1,3 W/m ² K	1,3 W/m ² K	1,3 W/m ² K
70 mm	1,3 W/m ² K	1,3 W/m ² K	1,3 W/m ² K	1,2 W/m ² K	1,2 W/m ² K	1,2 W/m ² K

Glas Verre Glass	76.140 Pfosten 60/180 Montant 60/180 Mullion 60/180	76.141 Pfosten 60/220 Montant 60/220 Mullion 60/220	76.142 Pfosten 60/280 Montant 60/280 Mullion 60/280	76.140 Riegel 60/180 Traverse 60/180 Transom 60/180	76.141 Riegel 60/220 Traverse 60/220 Transom 60/220	76.142 Riegel 60/280 Traverse 60/280 Transom 60/280
50 mm	1,4 W/m ² K	1,4 W/m ² K	1,4 W/m ² K	1,3 W/m ² K	1,3 W/m ² K	1,3 W/m ² K
70 mm	1,3 W/m ² K	1,3 W/m ² K	1,3 W/m ² K	1,2 W/m ² K	1,2 W/m ² K	1,2 W/m ² K

Der Einfluss der Schraubenbefestigung in Höhe von 0.14 W/m²K ist berücksichtigt.

L'influence de la fixation à vis de 0.14 W/m²K est prise en compte.

The 0.14 W/m²K influence of the screw fixing is taken into account.

System-Hinweise

Remarques concernant les systèmes

System instructions

VISS Fassade

VISS façade

VISS façade

**VISS 50 mm
Flaches Deckprofil**

U_f-Werte nach EN 10077-2

**VISS 50 mm
Profilé de recouvrement plat**

Valeurs U_f selon EN 10077-2

**VISS 50 mm
Flat cover cap**

U_f values according to 10077-2

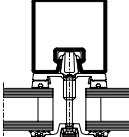
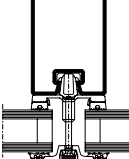
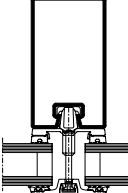
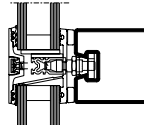
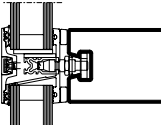
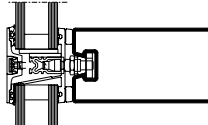
						
Glas Verre Glass	Pfosten 50/50 Montant 50/50 Mullion 50/50	Pfosten 50/95 Montant 50/95 Mullion 50/95	Pfosten 50/140 Montant 50/140 Mullion 50/140	Riegel 50/50 Traverse 50/50 Transom 50/50	Riegel 50/95 Traverse 50/95 Transom 50/95	Riegel 50/140 Traverse 50/140 Transom 50/140
20 mm	2,1 W/m²K	2,1 W/m²K	2,1 W/m²K	1,9 W/m²K	1,9 W/m²K	1,9 W/m²K
30 mm	1,8 W/m²K	1,9 W/m²K	1,9 W/m²K	1,6 W/m²K	1,7 W/m²K	1,7 W/m²K
40 mm	1,7 W/m²K	1,7 W/m²K	1,7 W/m²K	1,5 W/m²K	1,5 W/m²K	1,5 W/m²K
50 mm	1,6 W/m²K	1,6 W/m²K	1,6 W/m²K	1,5 W/m²K	1,5 W/m²K	1,5 W/m²K
60 mm	1,5 W/m²K	1,5 W/m²K	1,5 W/m²K	1,4 W/m²K	1,4 W/m²K	1,4 W/m²K
70 mm	1,5 W/m²K	1,5 W/m²K	1,5 W/m²K	1,4 W/m²K	1,4 W/m²K	1,4 W/m²K

**Der Einfluss der Schrauben-
befestigung in Höhe von 0.14 W/m²K
ist berücksichtigt.**

**L'influence de la fixation à vis de
0.14 W/m²K est prise en compte.**

**The 0.14 W/m²K influence of the
screw fixing is taken into account.**

System-Hinweise

Remarques concernant les systèmes

System instructions

VISS Fassade

VISS façade

VISS façade

VISS 60 mm
Flaches Deckprofil

U_f-Werte nach EN 10077-2

VISS 60 mm
Profilé de recouvrement plat

Valeurs U_f selon EN 10077-2

VISS 60 mm
Flat cover cap

U_f values according to 10077-2

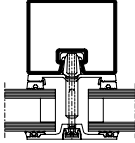
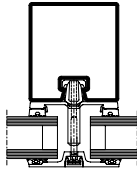
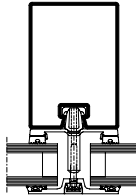
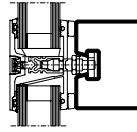
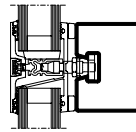
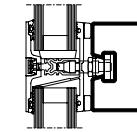
						
Glas Verre Glass	Pfosten 60/50 Montant 60/50 Mullion 60/50	Pfosten 60/100 Montant 60/100 Mullion 60/100	Pfosten 60/150 Montant 60/150 Mullion 60/150	Riegel 60/50 Traverse 60/50 Transom 60/50	Riegel 60/100 Traverse 60/100 Transom 60/100	Riegel 60/150 Traverse 60/150 Transom 60/150
20 mm	2,0 W/m ² K	2,0 W/m ² K	2,0 W/m ² K	1,8 W/m ² K	1,8 W/m ² K	1,8 W/m ² K
30 mm	1,7 W/m ² K	1,7 W/m ² K	1,7 W/m ² K	1,6 W/m ² K	1,6 W/m ² K	1,6 W/m ² K
40 mm	1,5 W/m ² K	1,5 W/m ² K	1,5 W/m ² K	1,5 W/m ² K	1,5 W/m ² K	1,5 W/m ² K
50 mm	1,4 W/m ² K	1,4 W/m ² K	1,4 W/m ² K	1,3 W/m ² K	1,4 W/m ² K	1,4 W/m ² K
60 mm	1,4 W/m ² K	1,4 W/m ² K	1,4 W/m ² K	1,3 W/m ² K	1,3 W/m ² K	1,3 W/m ² K
70 mm	1,3 W/m ² K	1,3 W/m ² K	1,3 W/m ² K	1,2 W/m ² K	1,3 W/m ² K	1,3 W/m ² K

	76.140	76.141	76.142	76.140	76.141	76.142
Glas Verre Glass	Pfosten 60/180 Montant 60/180 Mullion 60/180	Pfosten 60/220 Montant 60/220 Mullion 60/220	Pfosten 60/280 Montant 60/280 Mullion 60/280	Riegel 60/180 Traverse 60/180 Transom 60/180	Riegel 60/220 Traverse 60/220 Transom 60/220	Riegel 60/280 Traverse 60/280 Transom 60/280
50 mm	1,4 W/m ² K	1,4 W/m ² K	1,4 W/m ² K	1,3 W/m ² K	1,3 W/m ² K	1,3 W/m ² K
70 mm	1,3 W/m ² K	1,3 W/m ² K	1,3 W/m ² K	1,2 W/m ² K	1,2 W/m ² K	1,2 W/m ² K

Der Einfluss der Schraubenbefestigung in Höhe von 0.14 W/m²K ist berücksichtigt.

L'influence de la fixation à vis de 0.14 W/m²K est prise en compte.

The 0.14 W/m²K influence of the screw fixing is taken into account.

System-Hinweise

Remarques concernant les systèmes

System instructions

VISS Fassade

VISS façade

VISS façade

VISS TV 50 mm

U_f-Werte nach EN 10077-2

VISS TV 50 mm

Valeurs U_f selon EN 10077-2

VISS TV 50 mm

U_f values according to 10077-2

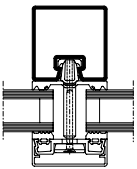
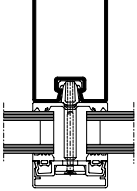
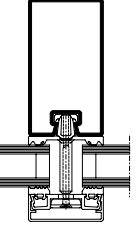
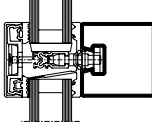
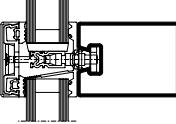
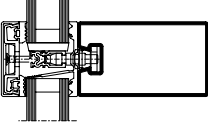
						
Glas Verre Glass	Pfosten 50/50 Montant 50/50 Mullion 50/50	Pfosten 50/95 Montant 50/95 Mullion 50/95	Pfosten 50/140 Montant 50/140 Mullion 50/140	Riegel 50/50 Traverse 50/50 Transom 50/50	Riegel 50/95 Traverse 50/95 Transom 50/95	Riegel 50/140 Traverse 50/140 Transom 50/140
20 mm	1,9 W/m²K	1,9 W/m²K	1,9 W/m²K	1,9 W/m²K	1,9 W/m²K	1,9 W/m²K
30 mm	1,8 W/m²K	1,8 W/m²K	1,8 W/m²K	1,7 W/m²K	1,7 W/m²K	1,7 W/m²K
40 mm	1,7 W/m²K	1,7 W/m²K	1,7 W/m²K	1,6 W/m²K	1,6 W/m²K	1,6 W/m²K
50 mm	1,5 W/m²K	1,6 W/m²K	1,6 W/m²K	1,5 W/m²K	1,5 W/m²K	1,6 W/m²K
60 mm	1,5 W/m²K	1,5 W/m²K	1,5 W/m²K	1,5 W/m²K	1,5 W/m²K	1,5 W/m²K
70 mm	1,4 W/m²K	1,5 W/m²K	1,5 W/m²K	1,5 W/m²K	1,5 W/m²K	1,5 W/m²K

Der Einfluss der Schraubenbefestigung in Höhe von 0.14 W/m²K ist berücksichtigt.

L'influence de la fixation à vis de 0.14 W/m²K est prise en compte.

The 0.14 W/m²K influence of the screw fixing is taken into account.

System-Hinweise

Remarques concernant les systèmes

System instructions

VISS Fassade

VISS façade

VISS façade

VISS TV 60 mm

U_f-Werte nach EN 10077-2

VISS TV 60 mm

Valeurs U_f selon EN 10077-2

VISS TV 60 mm

U_f values according to 10077-2

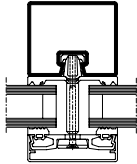
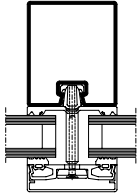
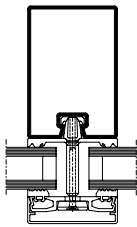
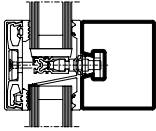
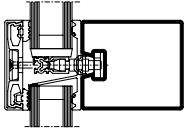
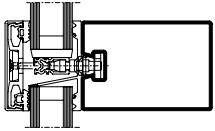
Glas Verre Glass						
	Pfosten 60/50 Montant 60/50 Mullion 60/50	Pfosten 60/100 Montant 60/100 Mullion 60/100	Pfosten 60/150 Montant 60/150 Mullion 60/150	Riegel 60/50 Traverse 60/50 Transom 60/50	Riegel 60/100 Traverse 60/100 Transom 60/100	Riegel 60/150 Traverse 60/150 Transom 60/150
20 mm	1,8 W/m ² K	1,8 W/m ² K	1,8 W/m ² K	1,8 W/m ² K	1,8 W/m ² K	1,8 W/m ² K
30 mm	1,6 W/m ² K	1,6 W/m ² K	1,6 W/m ² K	1,6 W/m ² K	1,6 W/m ² K	1,6 W/m ² K
40 mm	1,5 W/m ² K	1,5 W/m ² K	1,5 W/m ² K	1,5 W/m ² K	1,5 W/m ² K	1,5 W/m ² K
50 mm	1,4 W/m ² K	1,4 W/m ² K	1,4 W/m ² K	1,4 W/m ² K	1,4 W/m ² K	1,4 W/m ² K
60 mm	1,3 W/m ² K	1,3 W/m ² K	1,3 W/m ² K	1,3 W/m ² K	1,3 W/m ² K	1,3 W/m ² K
70 mm	1,3 W/m ² K	1,3 W/m ² K	1,3 W/m ² K	1,3 W/m ² K	1,3 W/m ² K	1,3 W/m ² K

Glas Verre Glass	76.140 Pfosten 60/180 Montant 60/180 Mullion 60/180	76.141 Pfosten 60/220 Montant 60/220 Mullion 60/220	76.142 Pfosten 60/280 Montant 60/280 Mullion 60/280	76.140 Riegel 60/180 Traverse 60/180 Transom 60/180	76.141 Riegel 60/220 Traverse 60/220 Transom 60/220	76.142 Riegel 60/280 Traverse 60/280 Transom 60/280
50 mm	1,4 W/m ² K	1,4 W/m ² K	1,4 W/m ² K	1,4 W/m ² K	1,4 W/m ² K	1,4 W/m ² K
70 mm	1,3 W/m ² K	1,3 W/m ² K	1,3 W/m ² K	1,3 W/m ² K	1,3 W/m ² K	1,3 W/m ² K

Der Einfluss der Schraubenbefestigung in Höhe von 0.14 W/m²K ist berücksichtigt.

L'influence de la fixation à vis de 0.14 W/m²K est prise en compte.

The 0.14 W/m²K influence of the screw fixing is taken into account.

System-Hinweise

Remarques concernant les systèmes

System instructions

VISS Fassade

VISS façade

VISS façade

VISS TV 50 mm
Flaches Deckprofil U_f -Werte nach EN 10077-2**VISS TV 50 mm**
Profilé de recouvrement platValeurs U_f selon EN 10077-2**VISS TV 50 mm**
Flat cover cap U_f values according to 10077-2

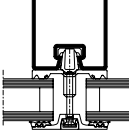
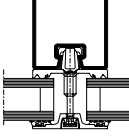
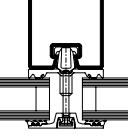
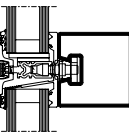
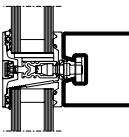
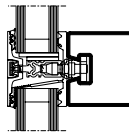
						
Glas Verre Glass	Pfofen 50/50 Montant 50/50 Mullion 50/50	Pfofen 50/95 Montant 50/95 Mullion 50/95	Pfofen 50/140 Montant 50/140 Mullion 50/140	Riegel 50/50 Traverse 50/50 Transom 50/50	Riegel 50/95 Traverse 50/95 Transom 50/95	Riegel 50/140 Traverse 50/140 Transom 50/140
20 mm	2,1 W/m²K	2,1 W/m²K	2,1 W/m²K	2,1 W/m²K	2,1 W/m²K	2,1 W/m²K
30 mm	1,8 W/m²K	1,9 W/m²K	1,9 W/m²K	1,8 W/m²K	1,8 W/m²K	1,8 W/m²K
40 mm	1,7 W/m²K	1,7 W/m²K	1,7 W/m²K	1,7 W/m²K	1,7 W/m²K	1,7 W/m²K
50 mm	1,6 W/m²K	1,6 W/m²K	1,6 W/m²K	1,6 W/m²K	1,6 W/m²K	1,6 W/m²K
60 mm	1,5 W/m²K	1,5 W/m²K	1,5 W/m²K	1,5 W/m²K	1,5 W/m²K	1,6 W/m²K
70 mm	1,5 W/m²K	1,4 W/m²K	1,5 W/m²K	1,5 W/m²K	1,5 W/m²K	1,5 W/m²K

Der Einfluss der Schraubenbefestigung in Höhe von 0.14 W/m²K ist berücksichtigt.

L'influence de la fixation à vis de 0.14 W/m²K est prise en compte.

The 0.14 W/m²K influence of the screw fixing is taken into account.

VISS TV 60 mm
Flaches Deckprofil
U_f-Werte nach EN 10077-2

VISS TV 60 mm
Profilé de recouvrement plat
Valeurs U_f selon EN 10077-2

VISS TV 60 mm
Flat cover cap
U_f values according to 10077-2

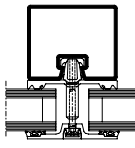
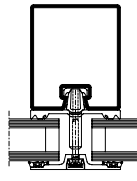
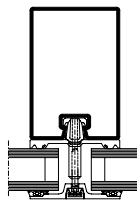
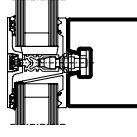
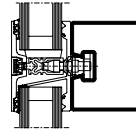
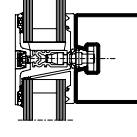
						
Glas Verre Glass	Pfosten 60/50 Montant 60/50 Mullion 60/50	Pfosten 60/100 Montant 60/100 Mullion 60/100	Pfosten 60/150 Montant 60/150 Mullion 60/150	Riegel 60/50 Traverse 60/50 Transom 60/50	Riegel 60/100 Traverse 60/100 Transom 60/100	Riegel 60/150 Traverse 60/150 Transom 60/150
20 mm	2,0 W/m²K	2,0 W/m²K	2,0 W/m²K	2,0 W/m²K	2,0 W/m²K	2,0 W/m²K
30 mm	1,7 W/m²K	1,7 W/m²K	1,7 W/m²K	1,7 W/m²K	1,7 W/m²K	1,7 W/m²K
40 mm	1,5 W/m²K	1,5 W/m²K	1,5 W/m²K	1,6 W/m²K	1,6 W/m²K	1,6 W/m²K
50 mm	1,4 W/m²K	1,4 W/m²K	1,4 W/m²K	1,4 W/m²K	1,5 W/m²K	1,5 W/m²K
60 mm	1,4 W/m²K	1,4 W/m²K	1,4 W/m²K	1,4 W/m²K	1,4 W/m²K	1,4 W/m²K
70 mm	1,3 W/m²K	1,3 W/m²K	1,3 W/m²K	1,3 W/m²K	1,4 W/m²K	1,4 W/m²K

Glas Verre Glass	76.140 Pfosten 60/180 Montant 60/180 Mullion 60/180	76.141 Pfosten 60/220 Montant 60/220 Mullion 60/220	76.142 Pfosten 60/280 Montant 60/280 Mullion 60/280	76.140 Riegel 60/180 Traverse 60/180 Transom 60/180	76.141 Riegel 60/220 Traverse 60/220 Transom 60/220	76.142 Riegel 60/280 Traverse 60/280 Transom 60/280
50 mm	1,4 W/m²K	1,4 W/m²K	1,4 W/m²K	1,5 W/m²K	1,5 W/m²K	1,5 W/m²K
70 mm	1,3 W/m²K	1,3 W/m²K	1,3 W/m²K	1,4 W/m²K	1,4 W/m²K	1,4 W/m²K

**Der Einfluss der Schrauben-
befestigung in Höhe von 0.14 W/m²K
ist berücksichtigt.**

**L'influence de la fixation à vis de
0.14 W/m²K est prise en compte.**

**The 0.14 W/m²K influence of the
screw fixing is taken into account.**

CE Kennzeichnung
Marquage CE
CE marking

VISS Fassade
VISS façade
VISS façade

CE Kennzeichnung und Leistungserklärungen

Alle nötigen Unterlagen und Anleitungen zur CE-Kennzeichnung finden Sie unter

www.extranet.jansen.com

Marquage CE et déclarations de performance

Tous les documents et instructions relatifs au marquage CE se trouvent sur le site

www.extranet.jansen.com

CE marking and declarations of performance

You can find all the necessary documents and instructions on CE marking at

www.extranet.jansen.com

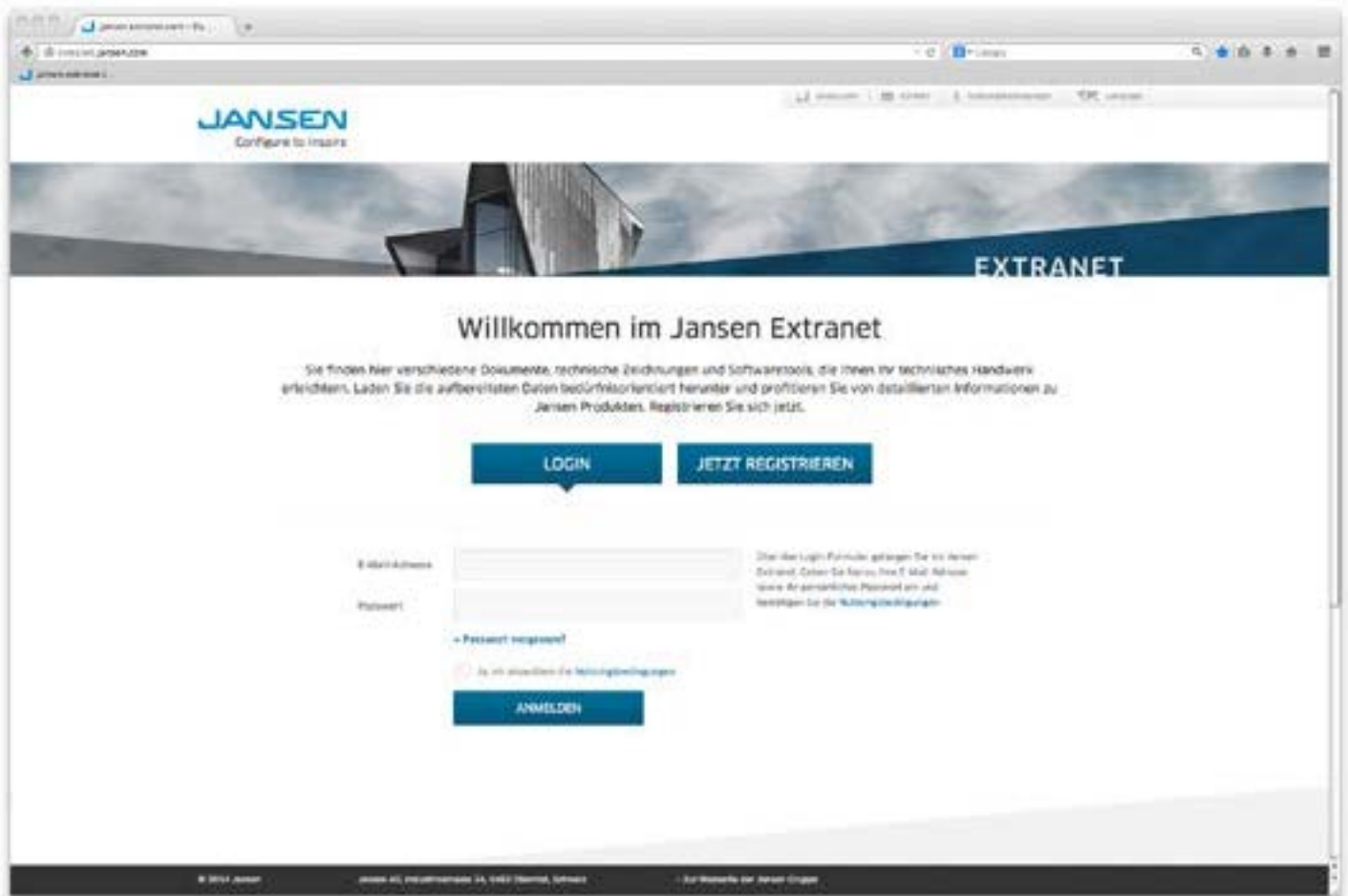

Jansen AG

Steel Systems
Industriestrasse 34
9463 Oberriet
Schweiz
jansen.com

